

Paths, trees and asteroids

Benjamin Lévêque

Chordal graphs

Chordal graphs

Definition

Graphs with no holes

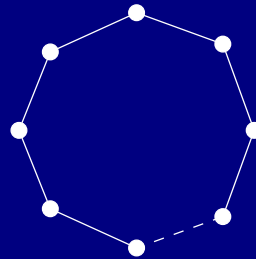

Chordal graphs

Definition

Graphs with no holes

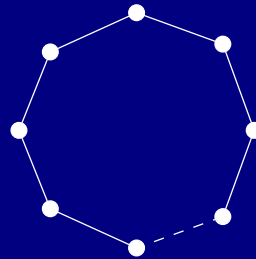

Theorem (Gavril - 1974)

Chordal \iff intersection graph of a family of subtrees of a tree

Chordal graphs

Definition

Graphs with no holes

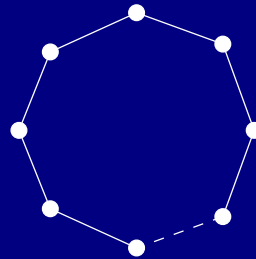

Theorem (Gavril - 1974)

Chordal \iff intersection graph of a family of subtrees of a tree



Chordal graphs

Definition

Graphs with no holes

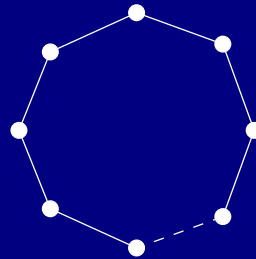

Theorem (Gavril - 1974)

Chordal \iff intersection graph of a family of subtrees of a tree

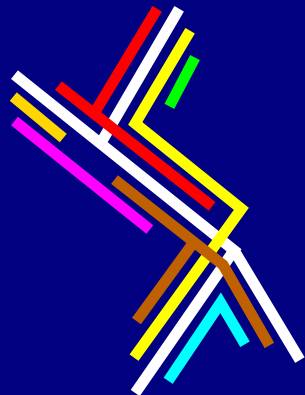

Chordal graphs

Definition

Graphs with no holes

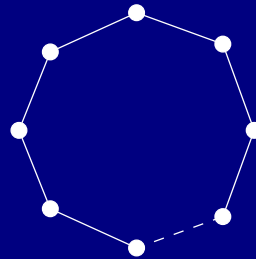

Theorem (Gavril - 1974)

Chordal \iff intersection graph of a family of subtrees of a tree

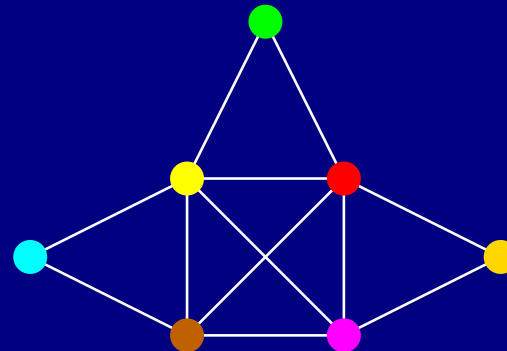
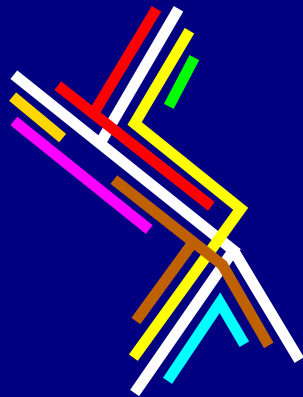

Interval graphs

Interval graphs

Definition

Intersection graph of a family of subpaths of a path

Interval graphs

Definition

Intersection graph of a family of subpaths of a path



Interval graphs

Definition

Intersection graph of a family of subpaths of a path

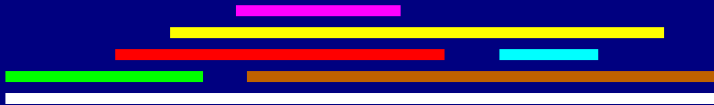

Interval graphs

Definition

Intersection graph of a family of subpaths of a path

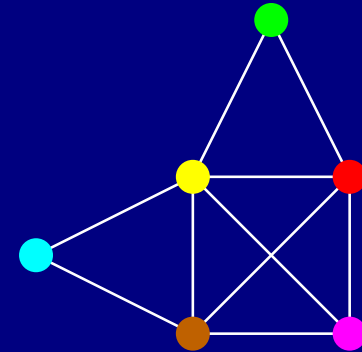

Interval graphs

Definition

Intersection graph of a family of subpaths of a path

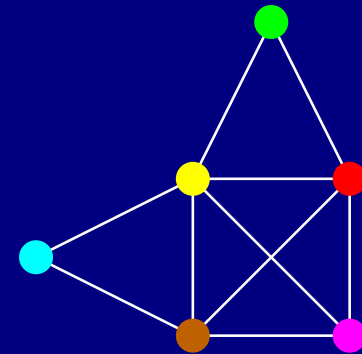
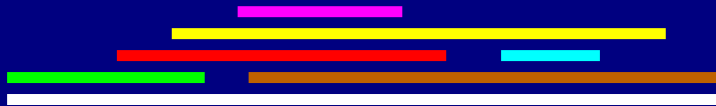

Asteroidal triple

3 non adjacent vertices such that between any two of them, there exists a path that does not intersect the neighborhood of the third.

Interval graphs

Definition

Intersection graph of a family of subpaths of a path

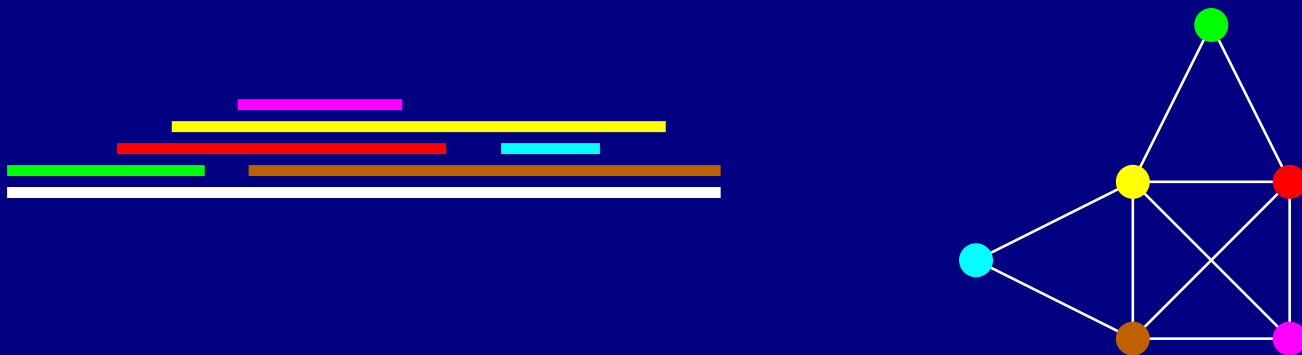

Asteroidal triple

3 non adjacent vertices such that between any two of them, there exists a path that does not intersect the neighborhood of the third.

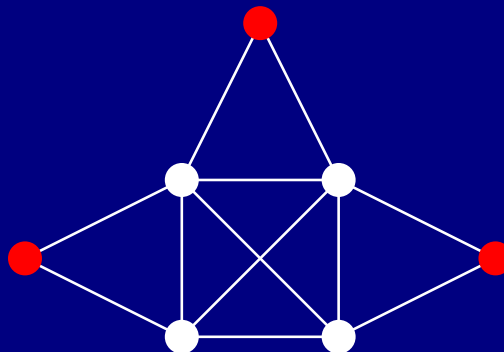

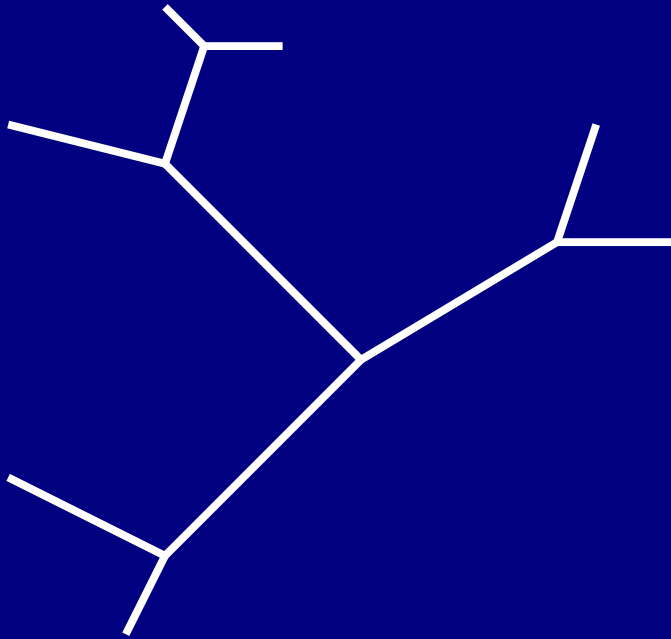



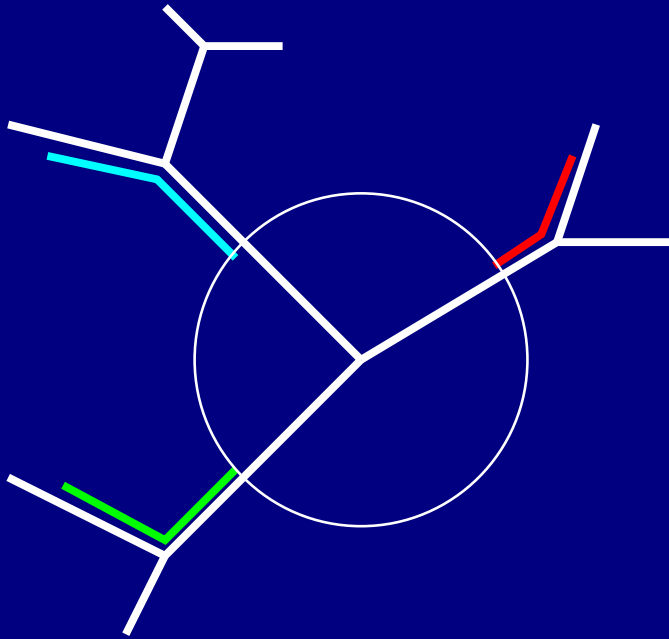

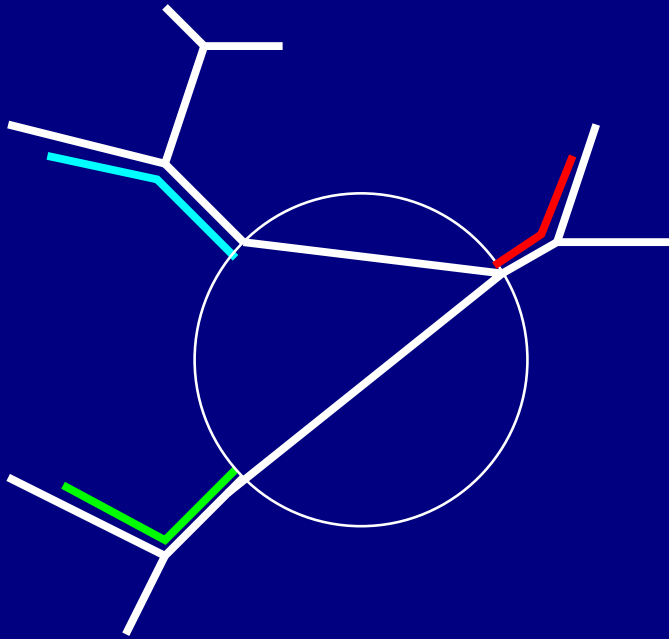

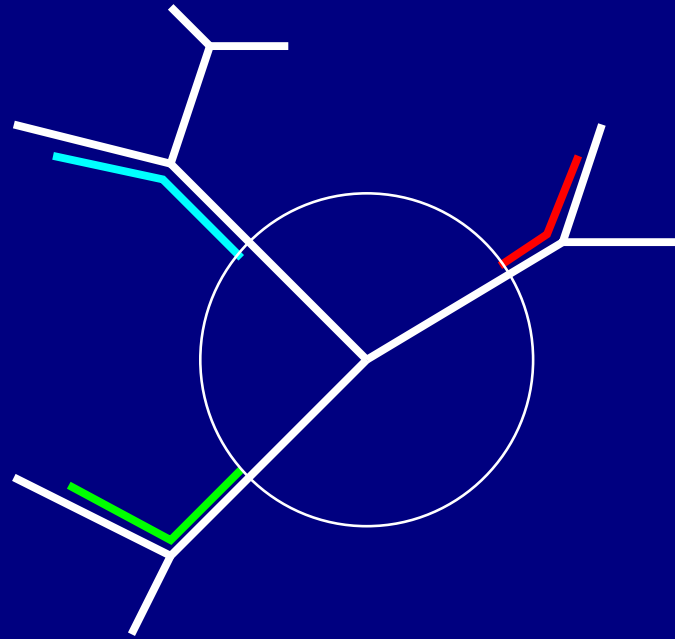

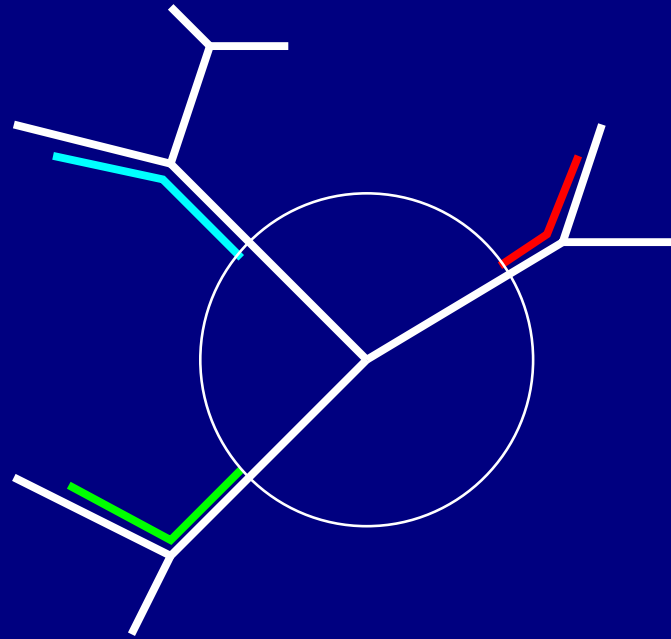

Theorem (Lekkerkerker and Boland - 1962)

Interval graph \iff chordal + no asteroidal triple

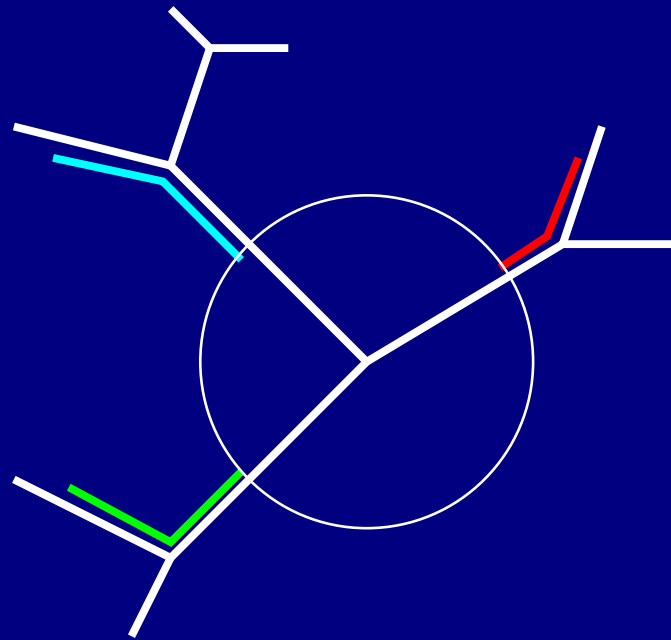

Theorem (Lekkerkerker and Boland - 1962)

Interval graph \iff chordal + no asteroidal triple

\iff it does not contain :

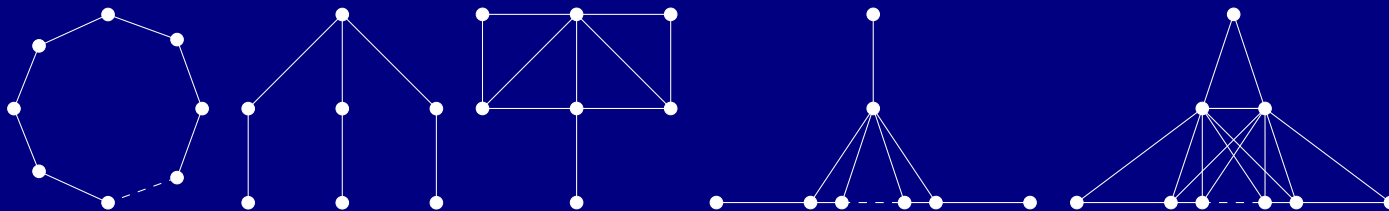

Path graphs

Path graphs

Definition

Intersection graph of a family of subpaths of a tree

Path graphs

Definition

Intersection graph of a family of subpaths of a tree



Path graphs

Definition

Intersection graph of a family of subpaths of a tree

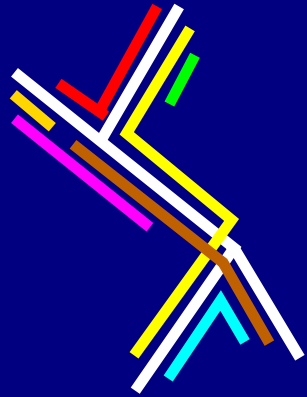

Path graphs

Definition

Intersection graph of a family of subpaths of a tree

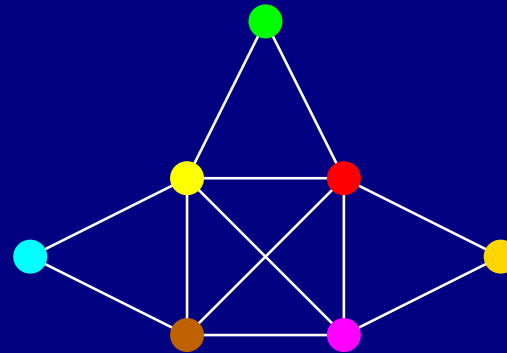
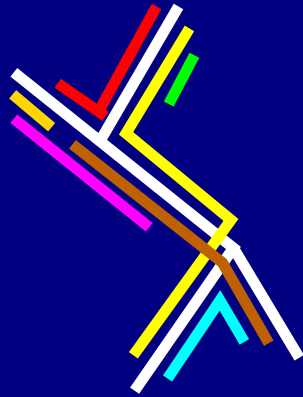

Path graphs

Definition

Intersection graph of a family of subpaths of a tree

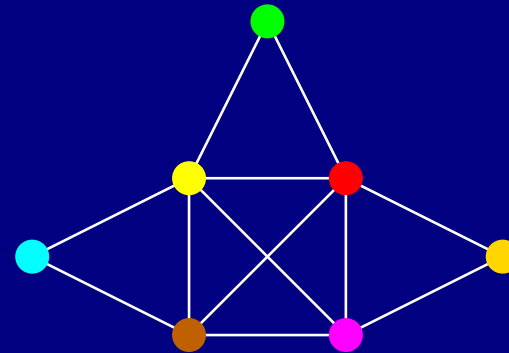
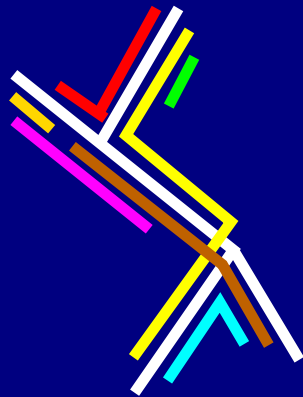

Question (Renz - 1970) :
Characterization by forbidden induced subgraphs ?

Neighborhoods in path graphs

Neighborhoods in path graphs

Remark

The neighborhood of every vertex is an interval graph

Neighborhoods in path graphs

Remark

The neighborhood of every vertex is an interval graph
 \implies a path graph does not contain :

Neighborhoods in path graphs

Remark

The neighborhood of every vertex is an interval graph
 \implies a path graph does not contain :

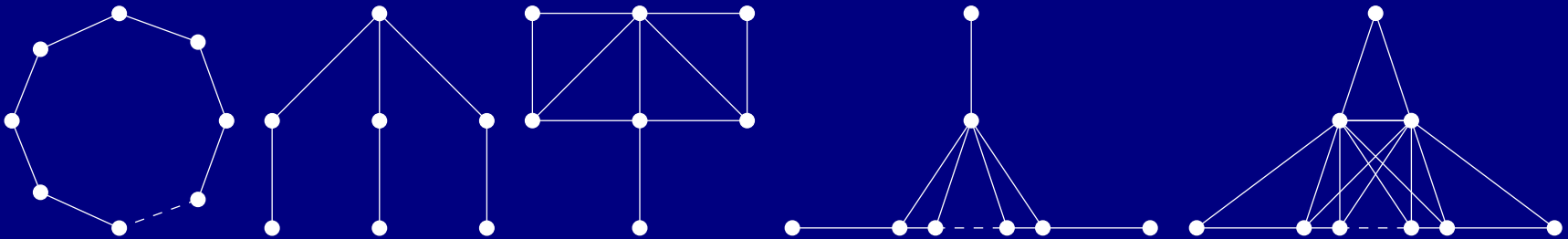

Neighborhoods in path graphs

Remark

The neighborhood of every vertex is an interval graph
 \implies a path graph does not contain :

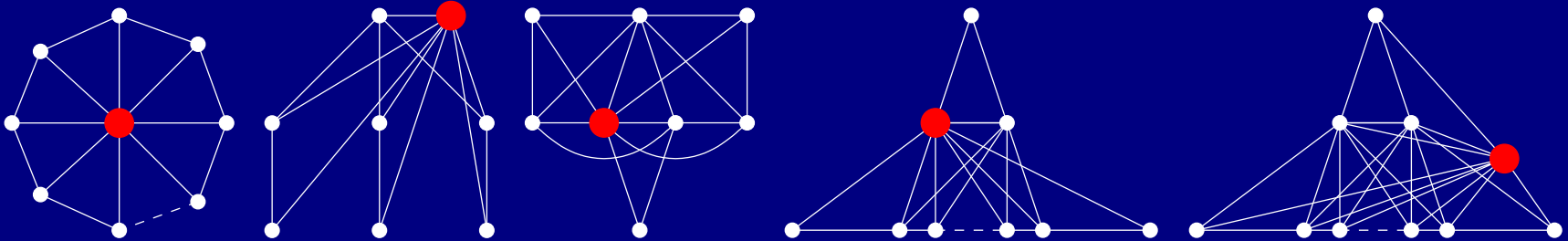

Neighborhoods in path graphs

Remark

The neighborhood of every vertex is an interval graph
 \implies a path graph does not contain :

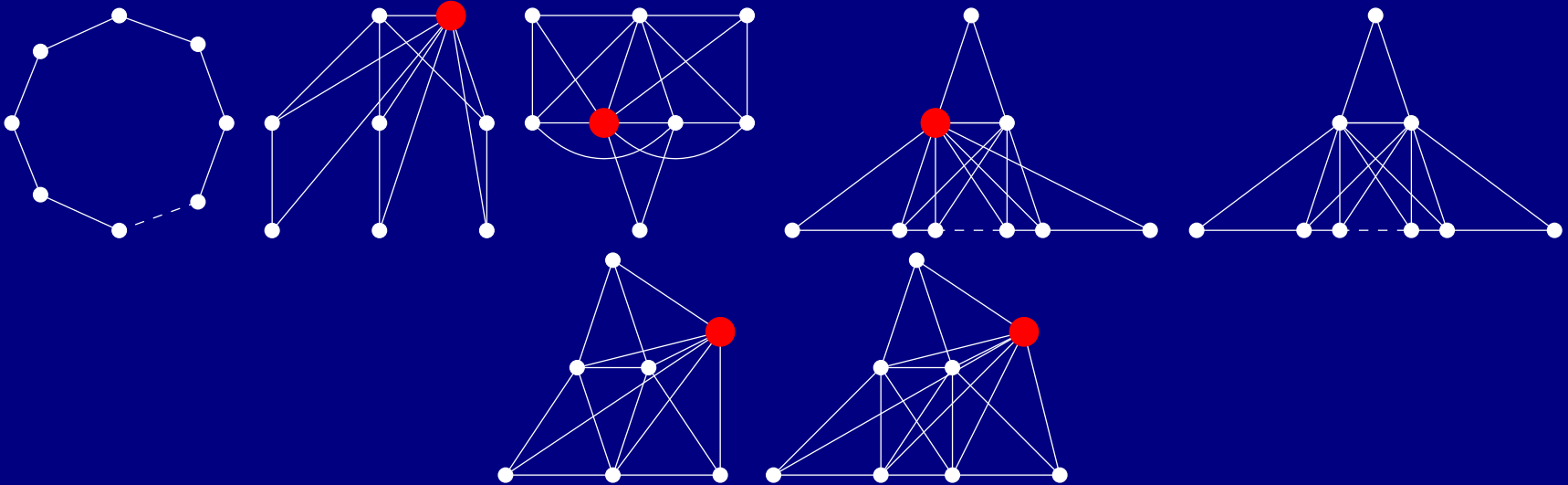

Neighborhoods in path graphs

Remark

The neighborhood of every vertex is an interval graph
 \implies a path graph does not contain :

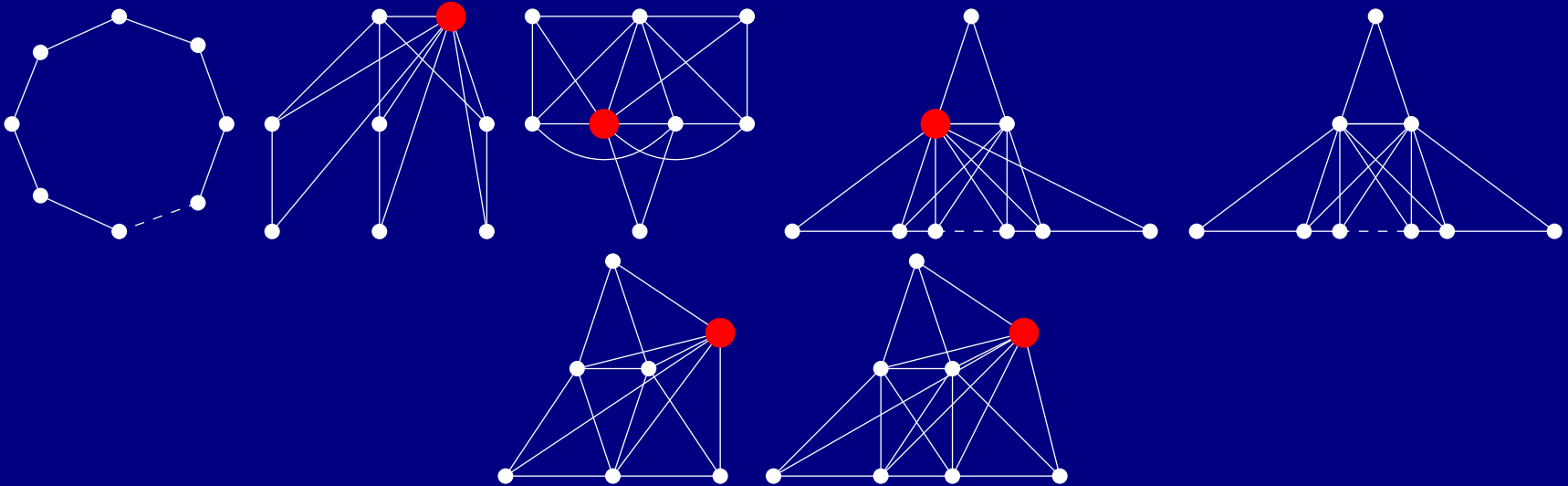

Question : Is that enough ?

Neighborhoods in path graphs

Remark

The neighborhood of every vertex is an interval graph
 \implies a path graph does not contain :

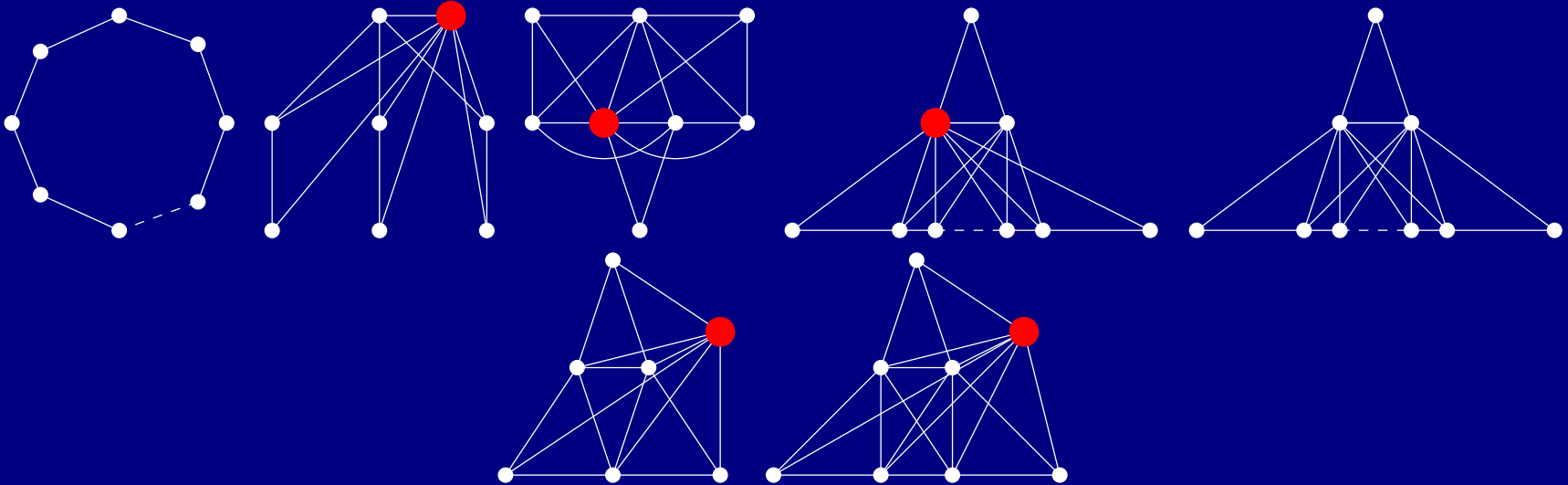

Question : Is that enough ?

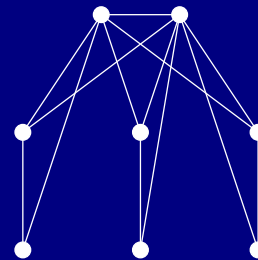

(Renz - 1970)

Theorem (Lévêque, Maffray and Preissmann - 2009)

Path graph \iff it does not contain :

Theorem (Lévêque, Maffray and Preissmann - 2009)

Path graph \iff it does not contain :

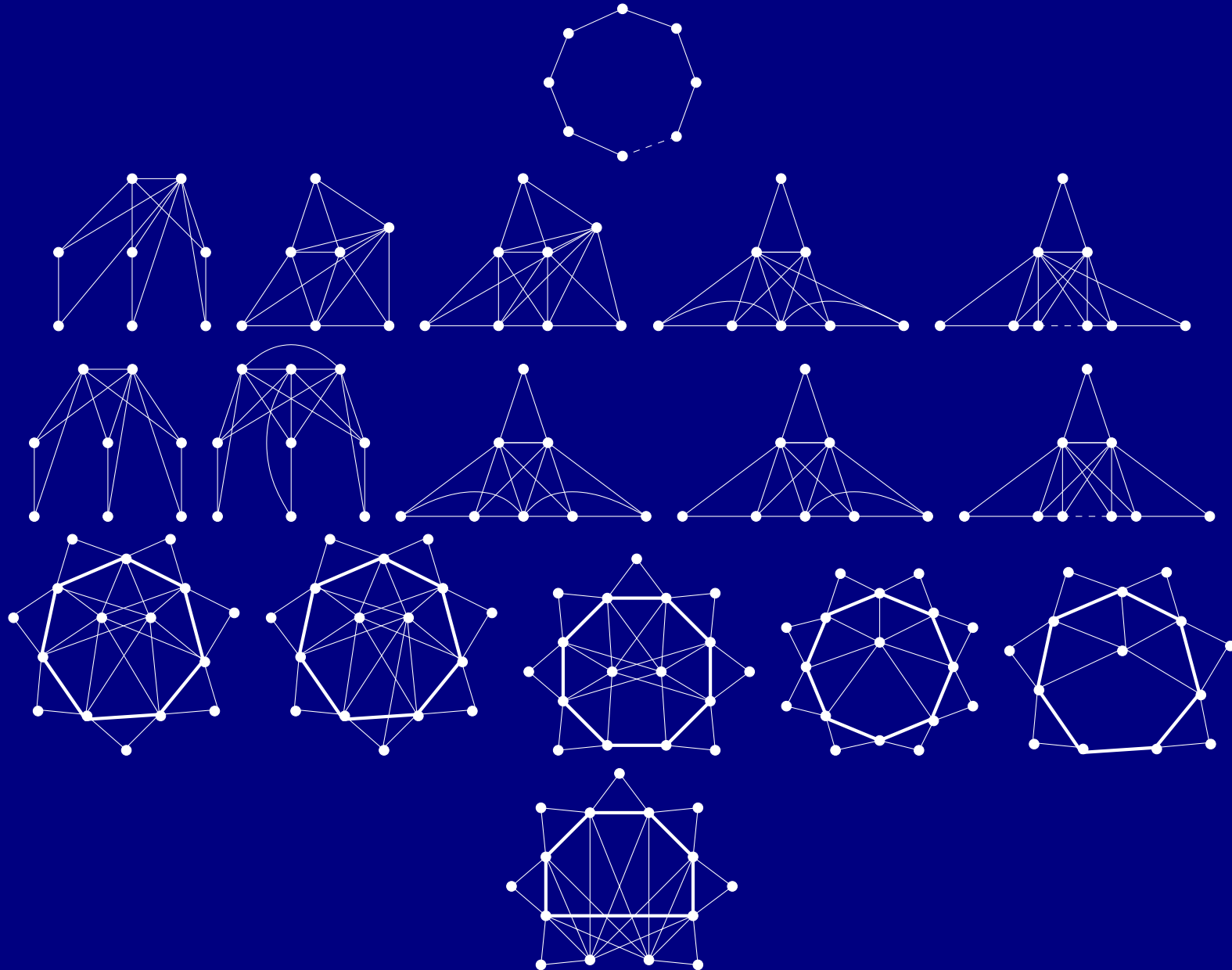

Simplicial vertices

Simplicial vertices

Theorem (Dirac - 1961)

Chordal, not a clique \implies 2 non adjacent simplicial vertices

Simplicial vertices

Theorem (Dirac - 1961)

Chordal, not a clique \implies 2 non adjacent simplicial vertices

Generalization (Lévêque, Maffray and Preissmann - 2009)

Chordal, not a clique \implies 2 non adjacent "special" simplicial vertices
($N[v] \cap N(V \setminus N[v])$ is a maximal separator)

Simplicial vertices

Theorem (Dirac - 1961)

Chordal, not a clique \implies 2 non adjacent simplicial vertices

Generalization (Lévêque, Maffray and Preissmann - 2009)

Chordal, not a clique \implies 2 non adjacent "special" simplicial vertices
($N[v] \cap N(V \setminus N[v])$ is a maximal separator)

Remark

LEXBFS and MCS do not necessarily find "special" simplicial vertices

Simplicial vertices

Theorem (Dirac - 1961)

Chordal, not a clique \implies 2 non adjacent simplicial vertices

Generalization (Lévêque, Maffray and Preissmann - 2009)

Chordal, not a clique \implies 2 non adjacent "special" simplicial vertices
($N[v] \cap N(V \setminus N[v])$ is a maximal separator)

Remark

LEXBFS and MCS do not necessarily find "special" simplicial vertices

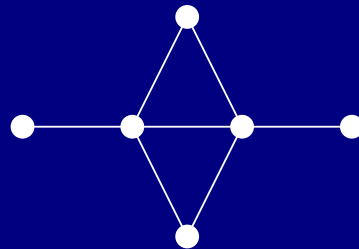

Simplicial vertices

Theorem (Dirac - 1961)

Chordal, not a clique \implies 2 non adjacent simplicial vertices

Generalization (Lévêque, Maffray and Preissmann - 2009)

Chordal, not a clique \implies 2 non adjacent "special" simplicial vertices
($N[v] \cap N(V \setminus N[v])$ is a maximal separator)

Remark

LEXBFS and MCS do not necessarily find "special" simplicial vertices

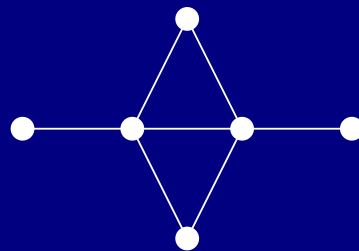

Question : "special" simplicial elimination ordering in linear time ?

Proof

Suppose there exists a graph minimally not path graph not in the list

Proof

Suppose there exists a graph minimally not path graph not in the list

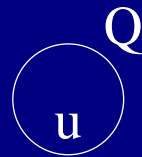

Proof

Suppose there exists a graph minimally not path graph not in the list



Proof

Suppose there exists a graph minimally not path graph not in the list

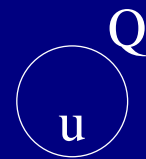
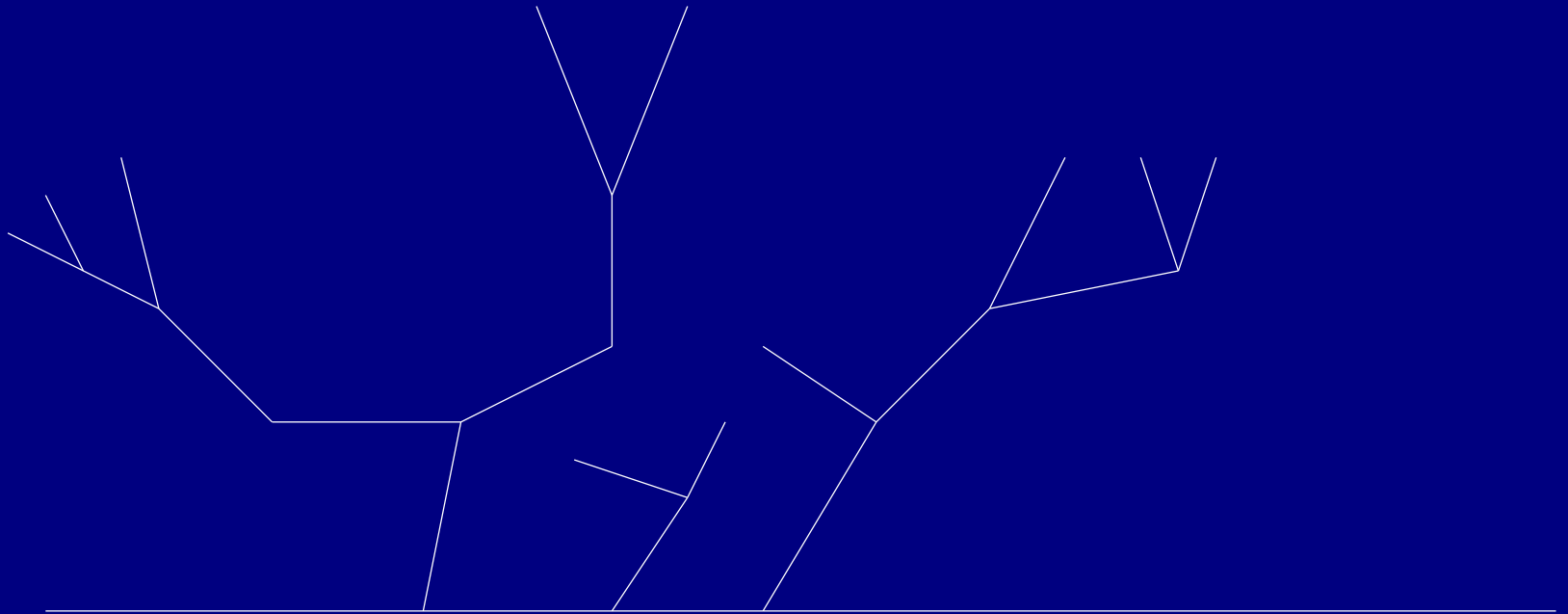

Proof

Suppose there exists a graph minimally not path graph not in the list

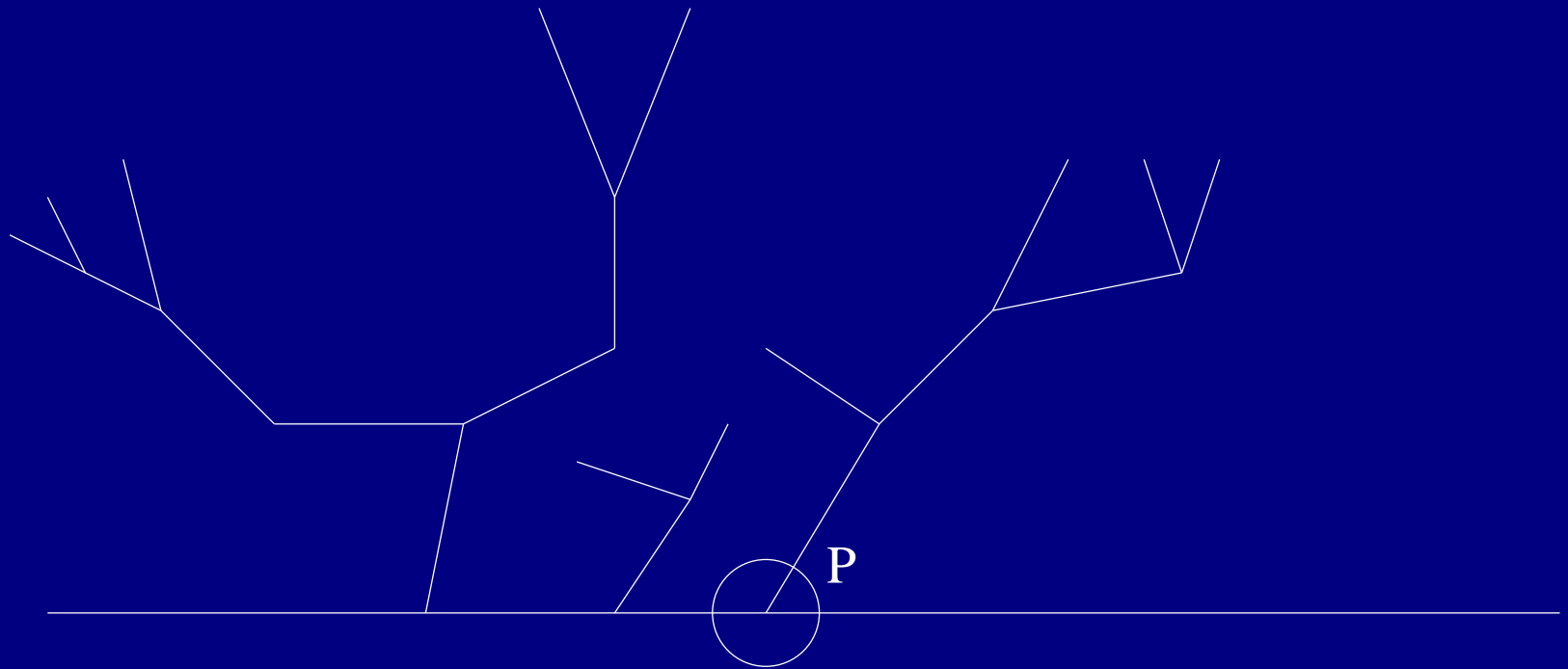

Proof

Suppose there exists a graph minimally not path graph not in the list

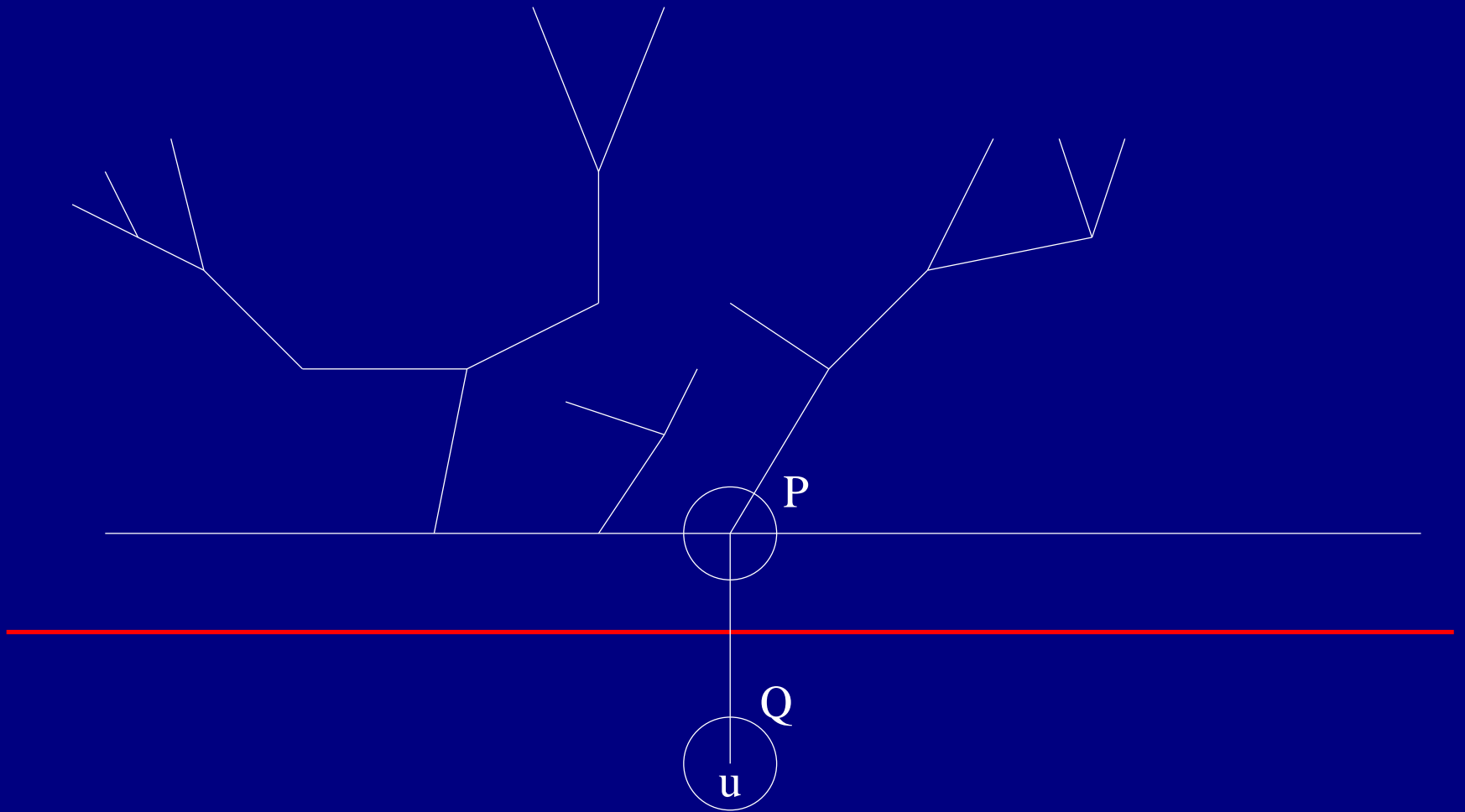

Proof

Suppose there exists a graph minimally not path graph not in the list

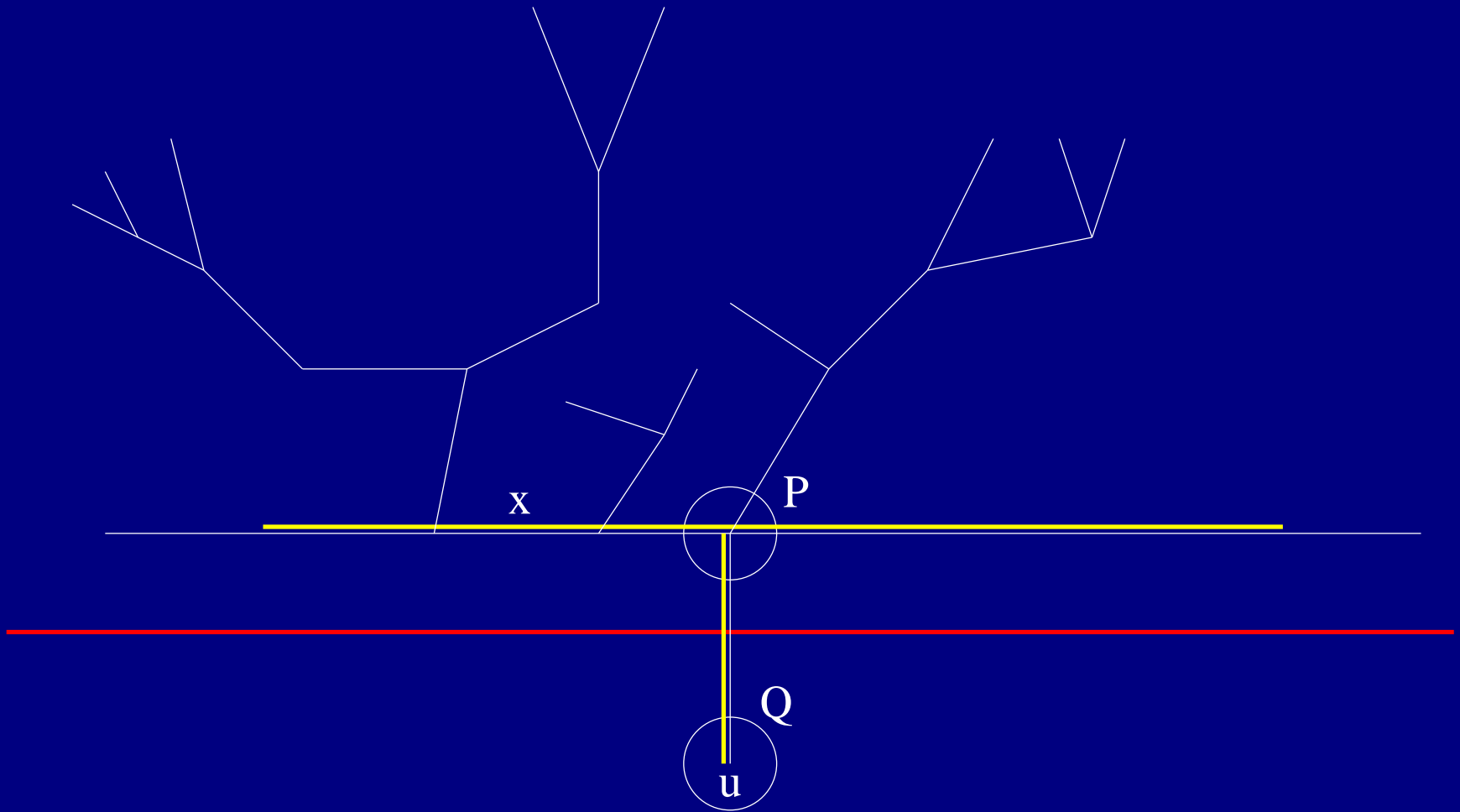

Proof

Suppose there exists a graph minimally not path graph not in the list

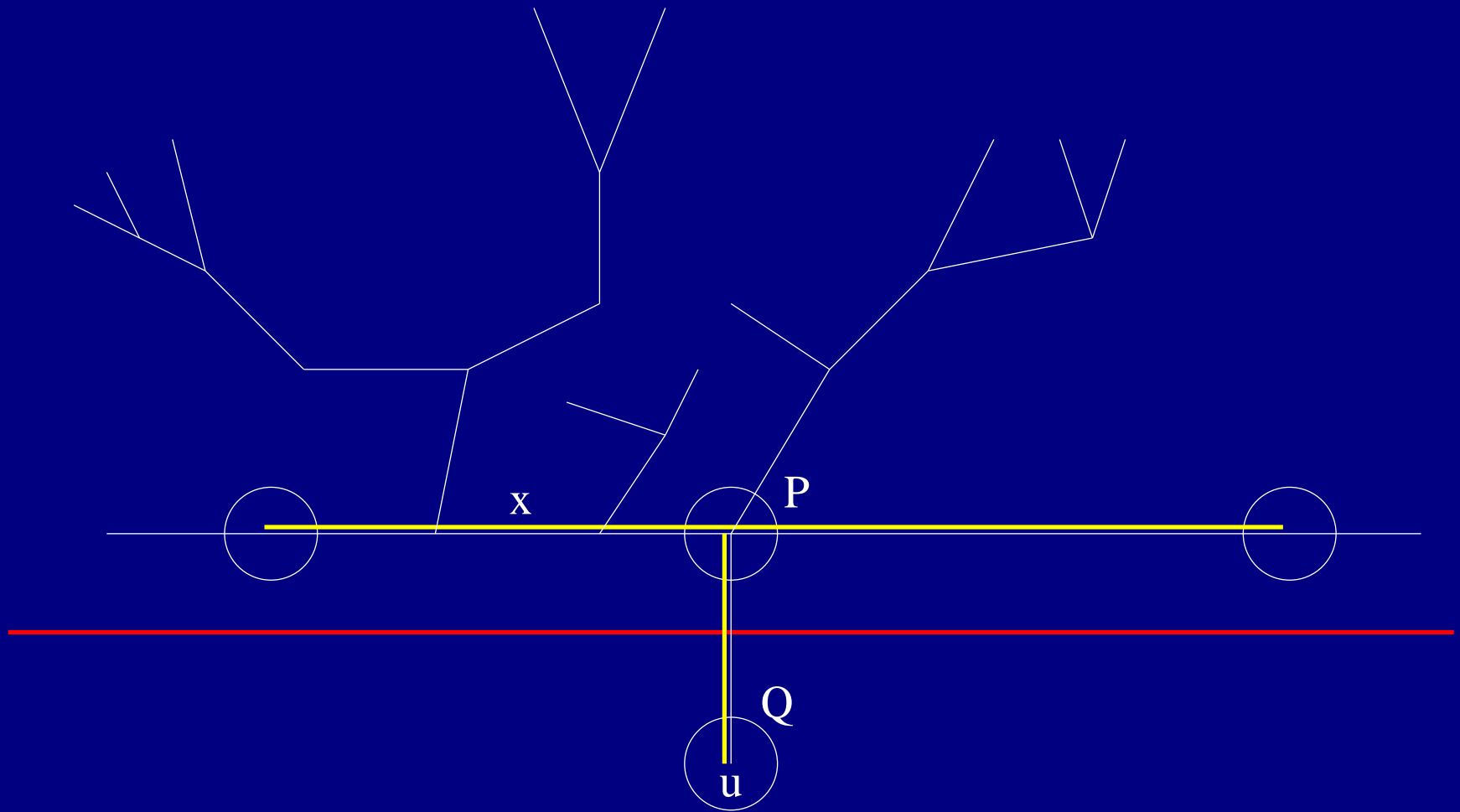

Proof

Suppose there exists a graph minimally not path graph not in the list

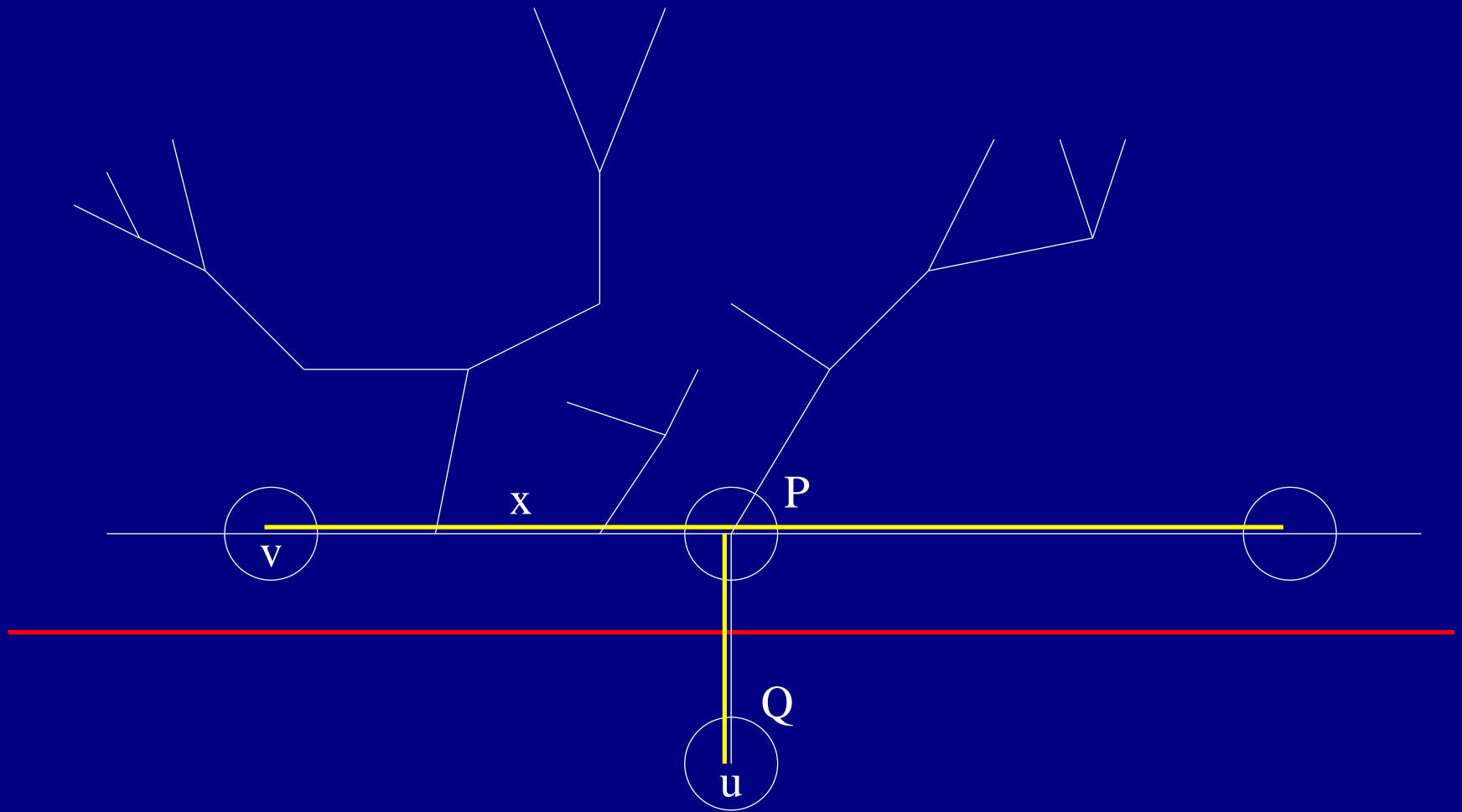

Proof

Suppose there exists a graph minimally not path graph not in the list

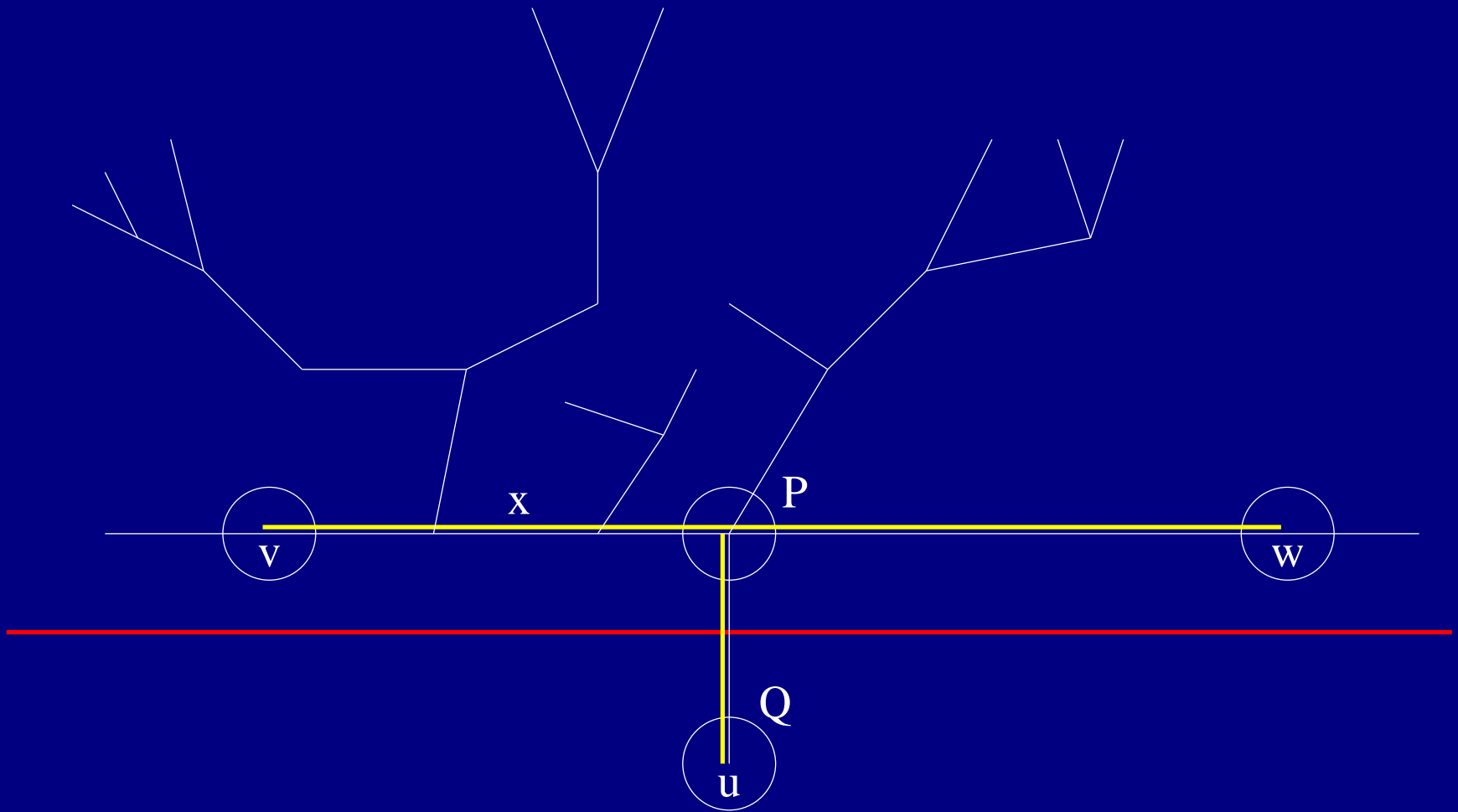

Proof

Suppose there exists a graph minimally not path graph not in the list

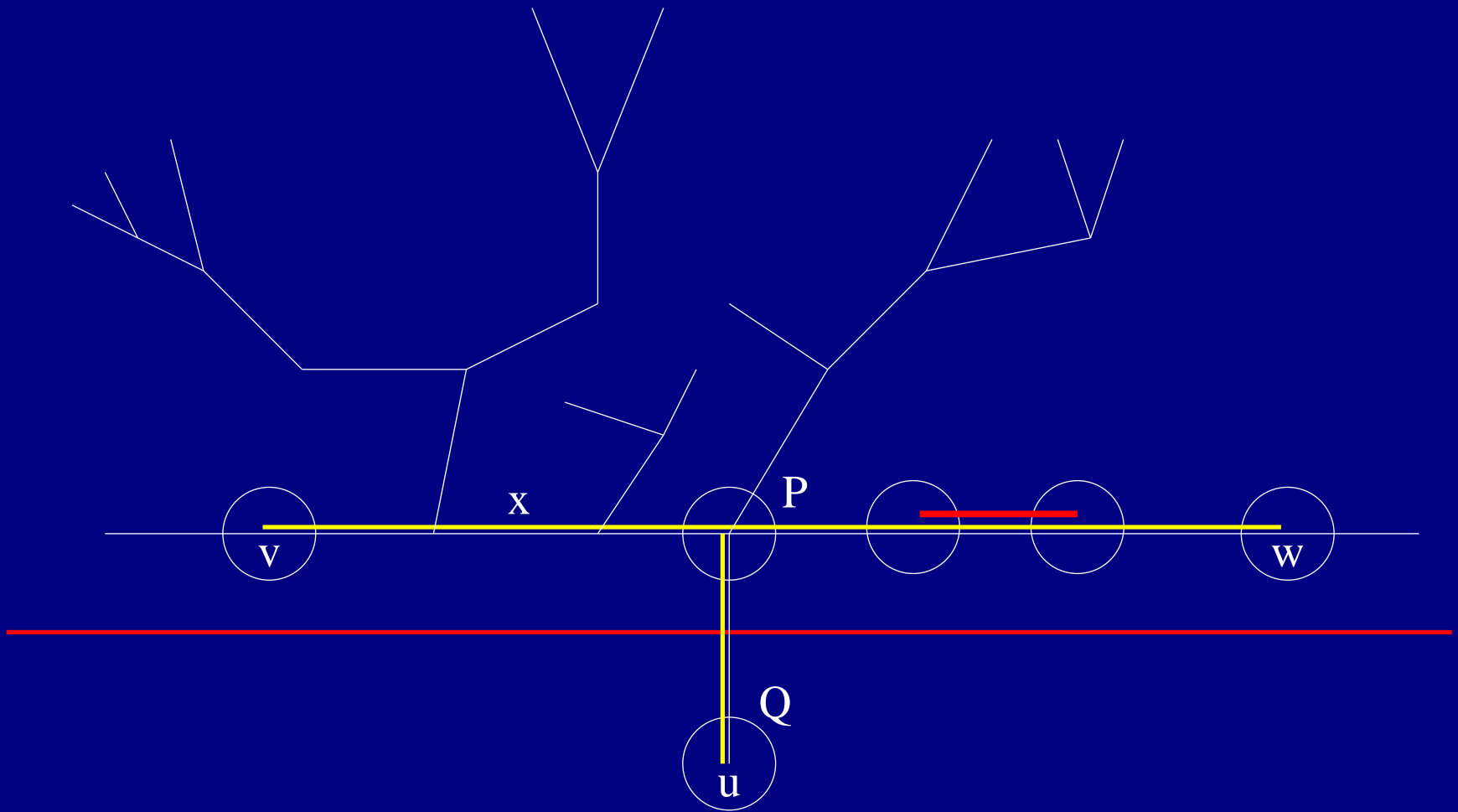

Proof

Suppose there exists a graph minimally not path graph not in the list

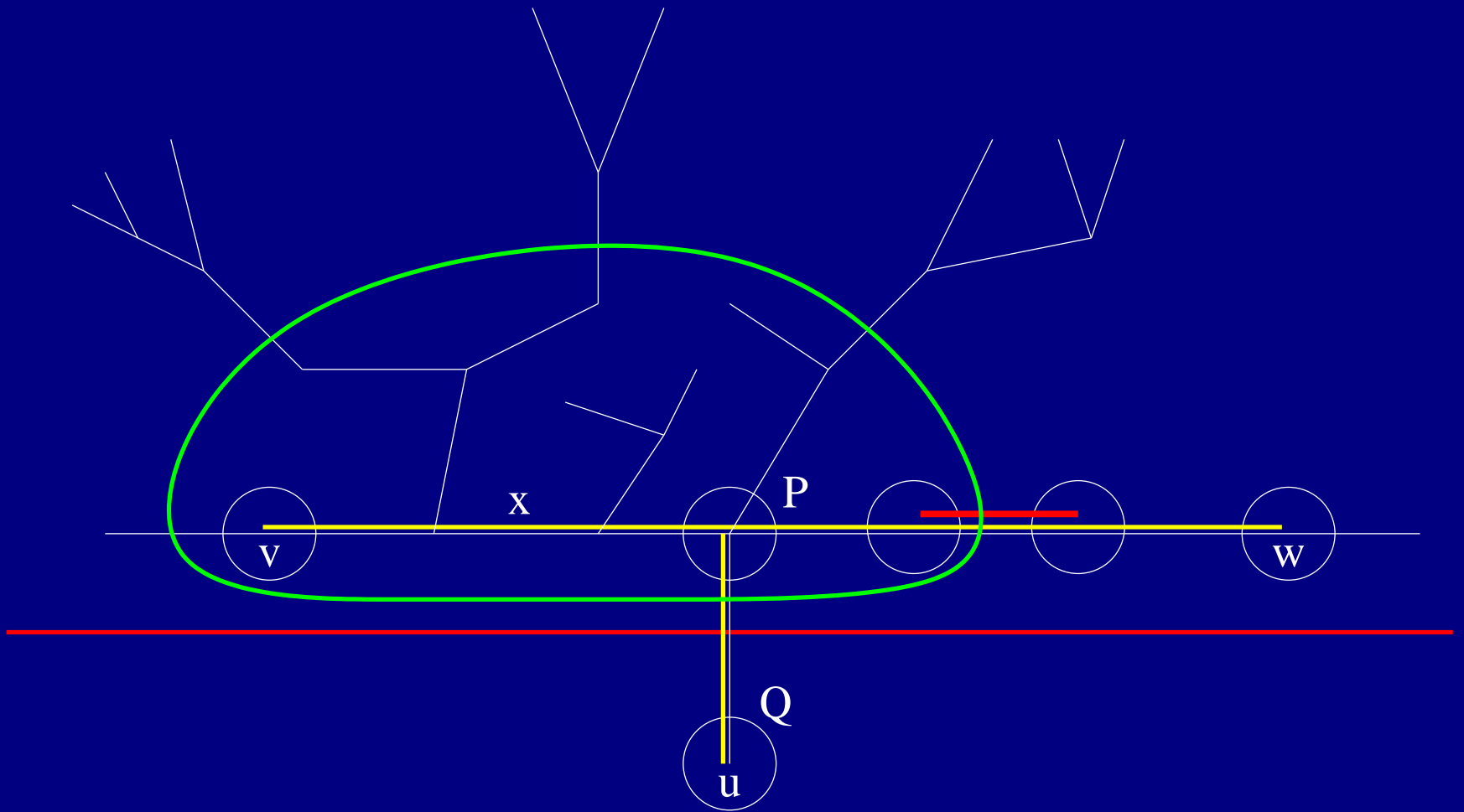

Proof

Suppose there exists a graph minimally not path graph not in the list

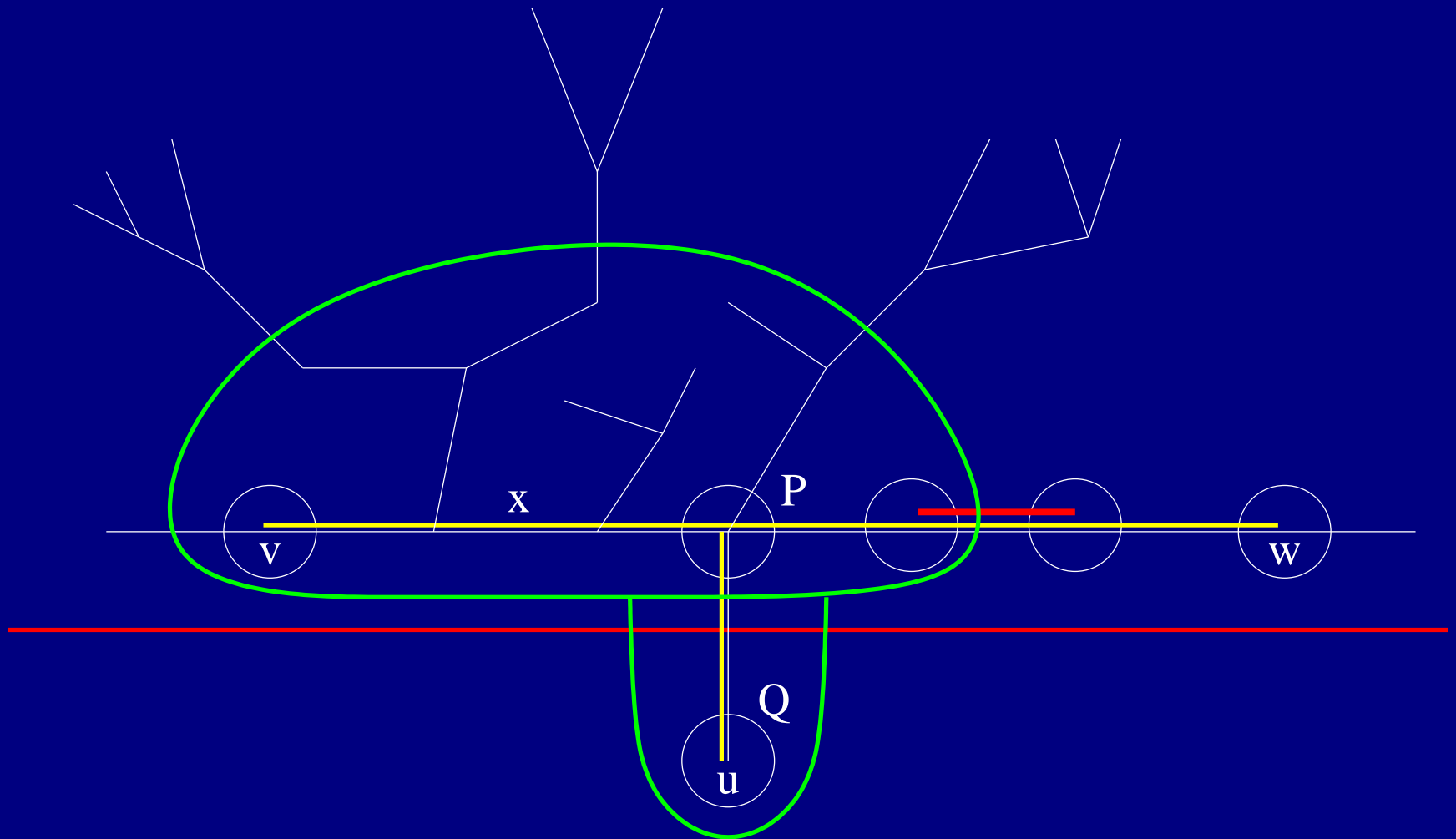

Proof

Suppose there exists a graph minimally not path graph not in the list

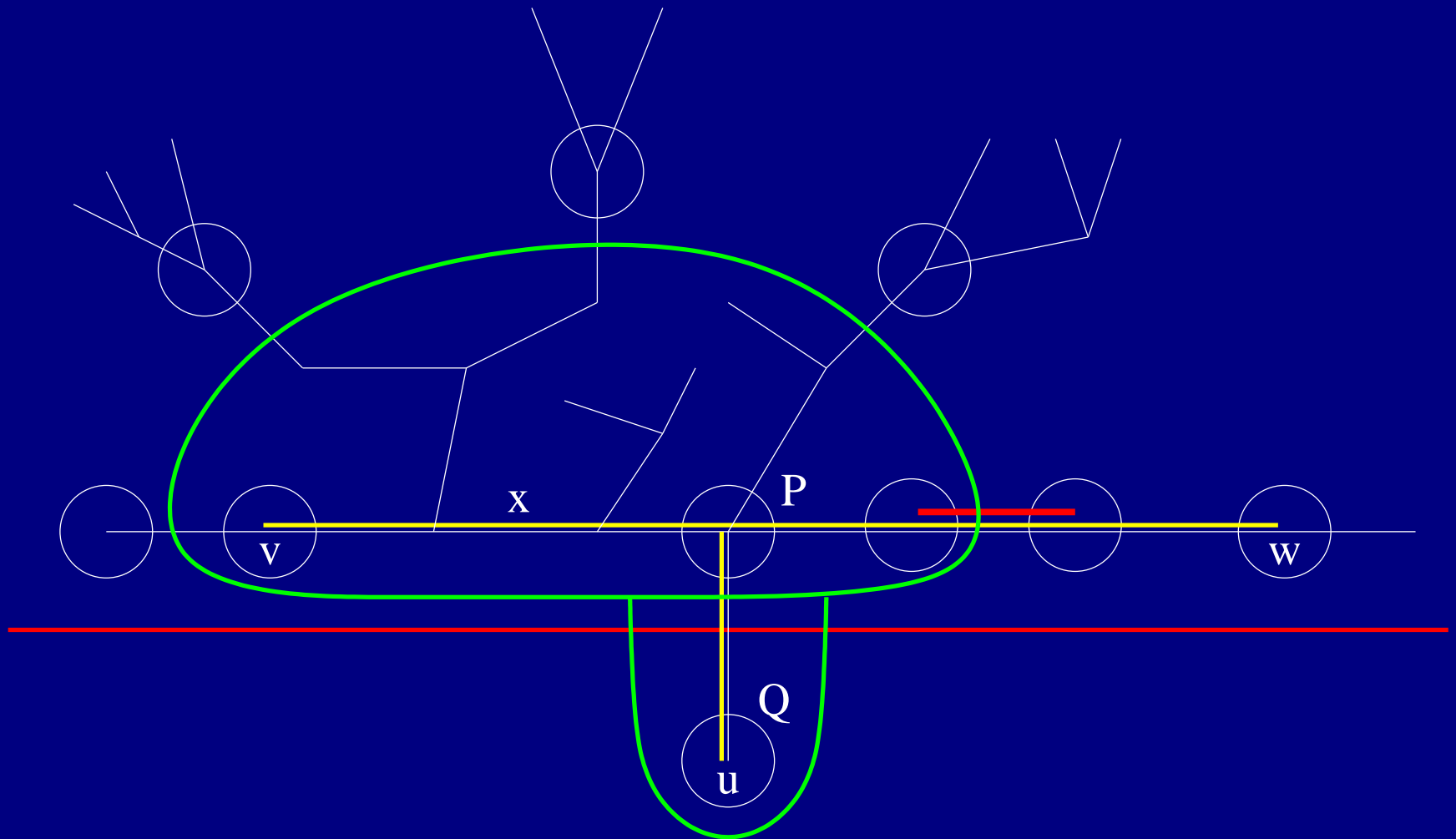

Proof

Suppose there exists a graph minimally not path graph not in the list

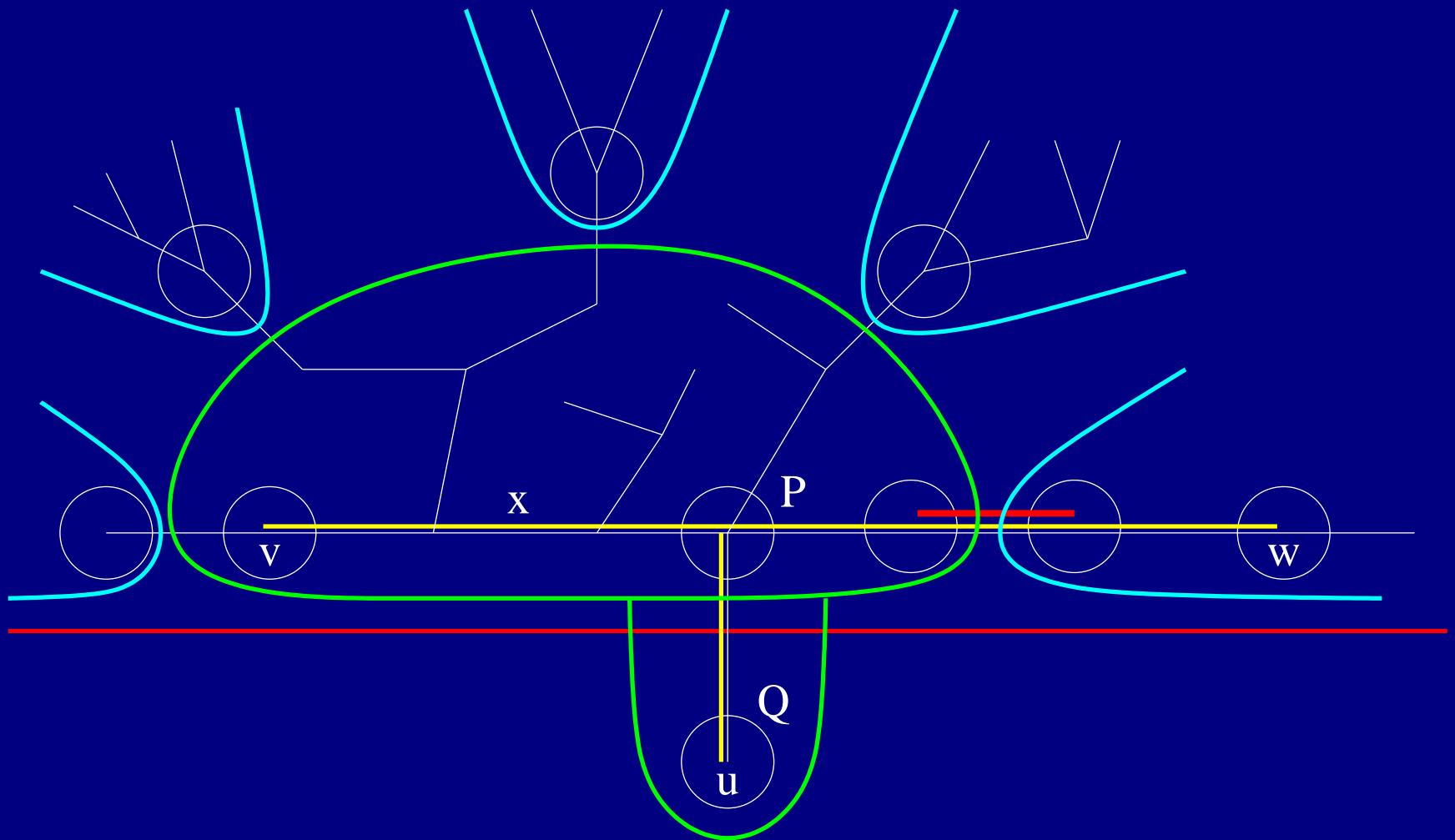

Directed path graphs

Directed path graphs

Definition

Intersection graph of a family of directed subpaths of a directed tree

Directed path graphs

Definition

Intersection graph of a family of directed subpaths of a directed tree

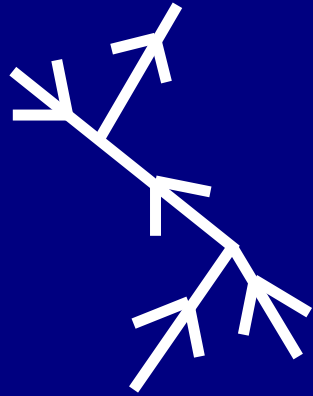

Directed path graphs

Definition

Intersection graph of a family of directed subpaths of a directed tree

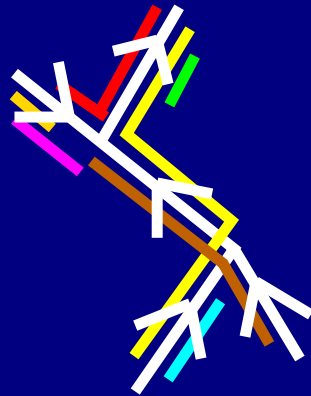

Directed path graphs

Definition

Intersection graph of a family of directed subpaths of a directed tree

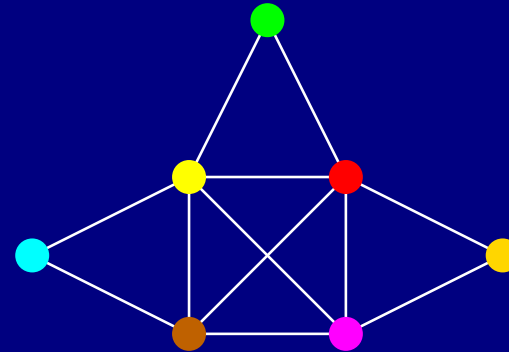
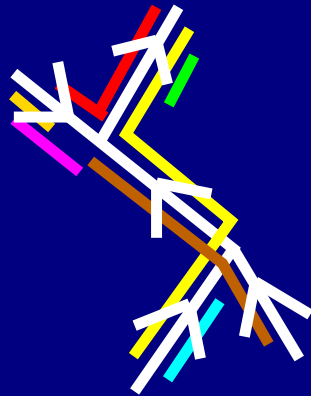

Directed path graphs

Definition

Intersection graph of a family of directed subpaths of a directed tree

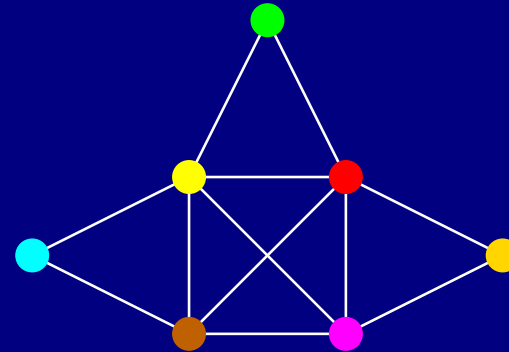
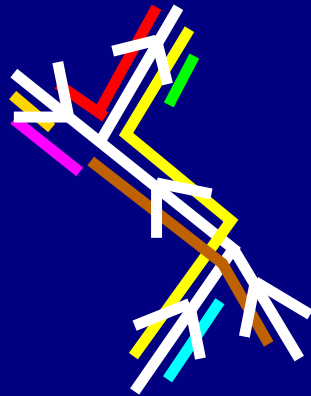

Theorem (Panda - 1999)

Directed path graph \iff it does not contain :

Directed path graphs

Definition

Intersection graph of a family of directed subpaths of a directed tree

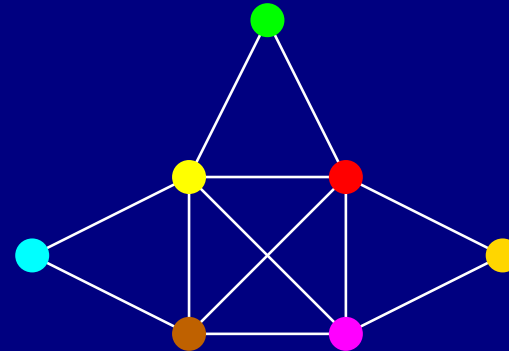
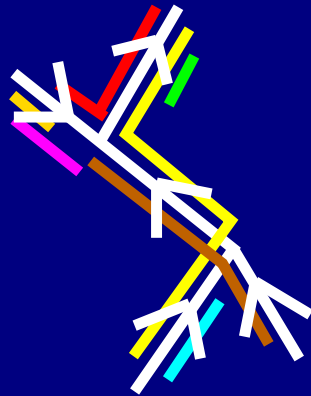

Theorem (Panda - 1999)

Directed path graph \iff it does not contain :

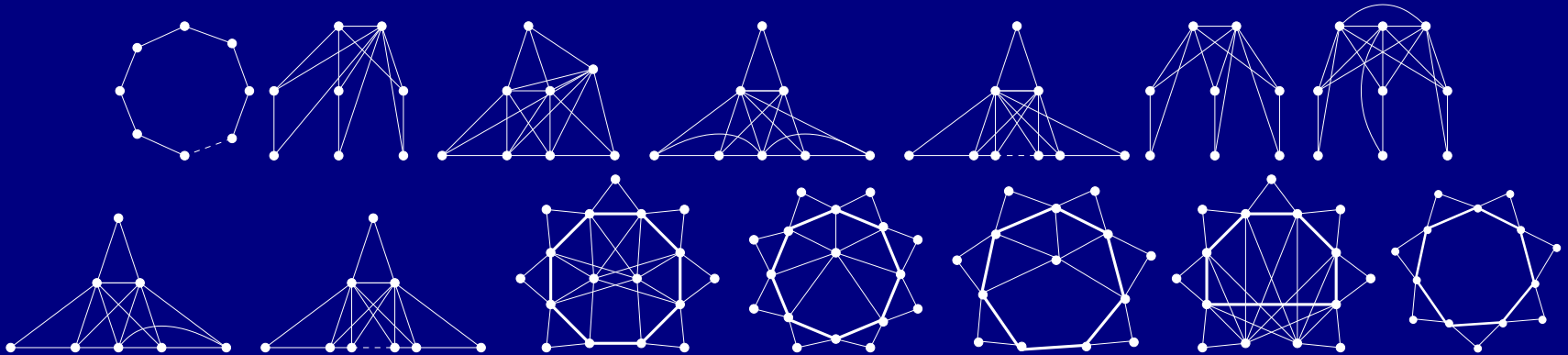

Strong path

Strong path

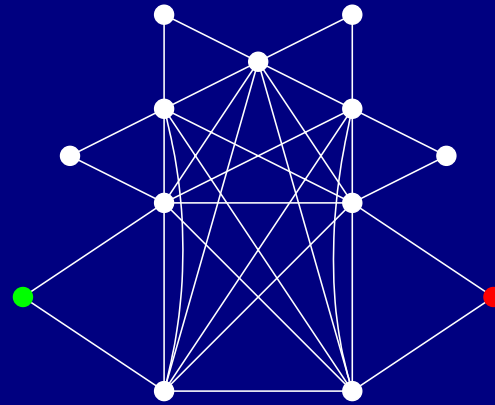
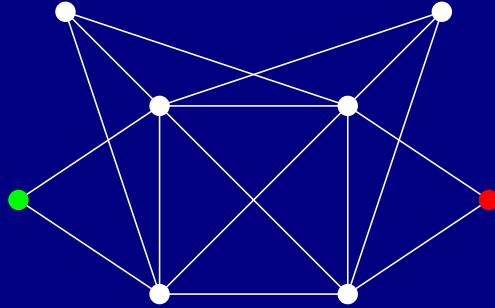
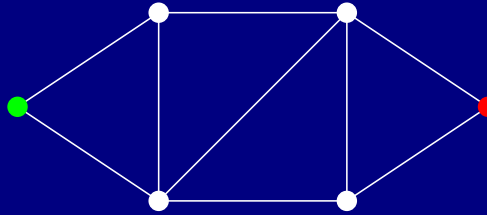

Strong path

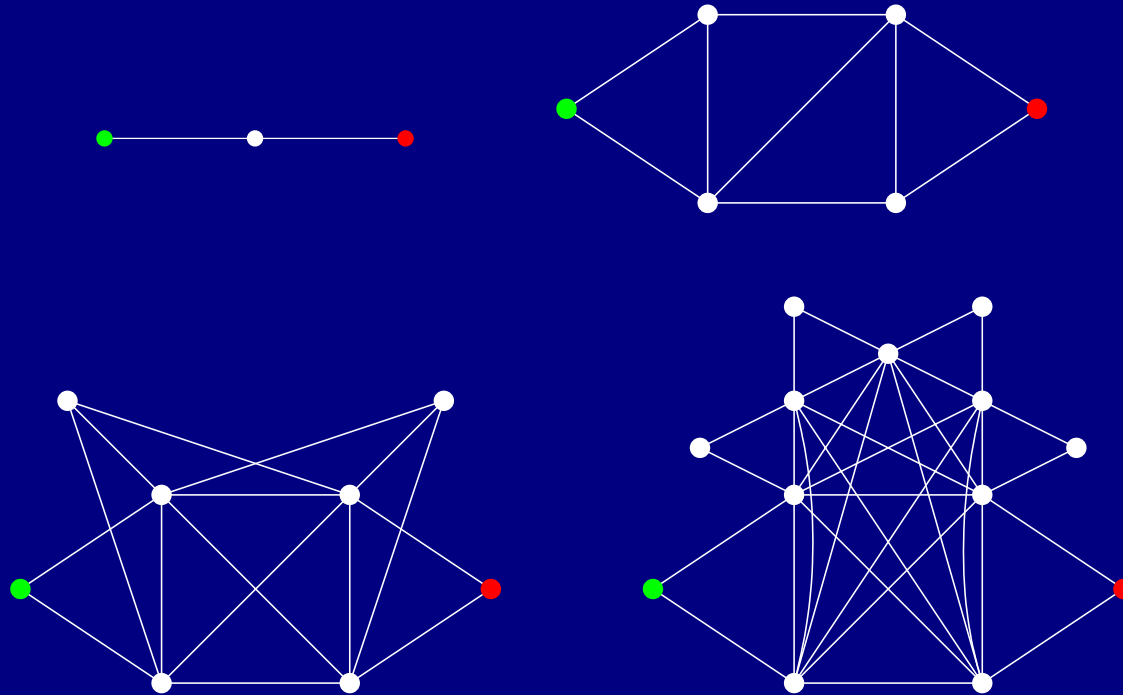

Property

In any directed path graph model the path between two vertices that are linked by a strong path is directed.

Strong path

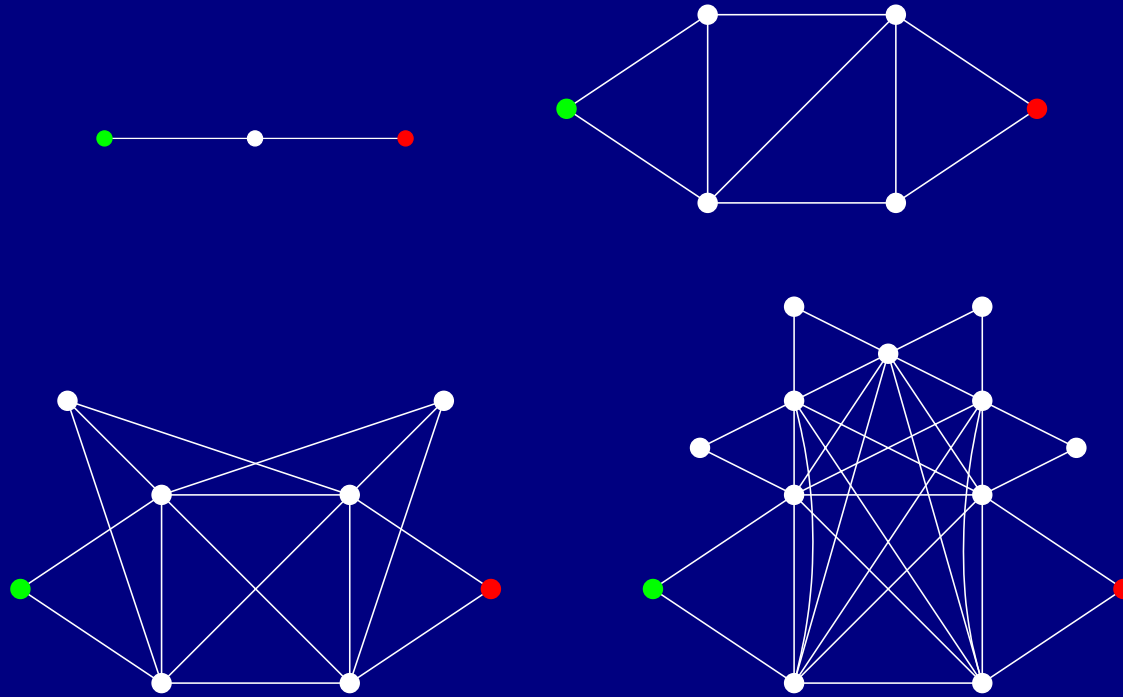

Property

In any directed path graph model the path between two vertices that are linked by a strong path is directed.

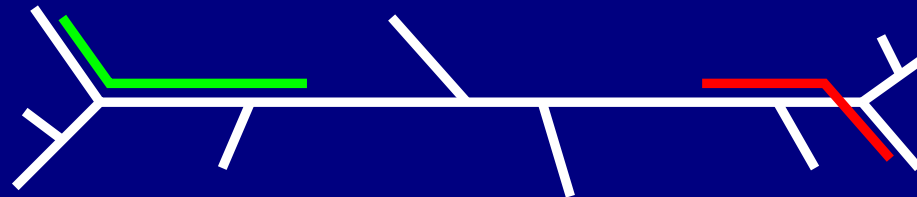

Strong path

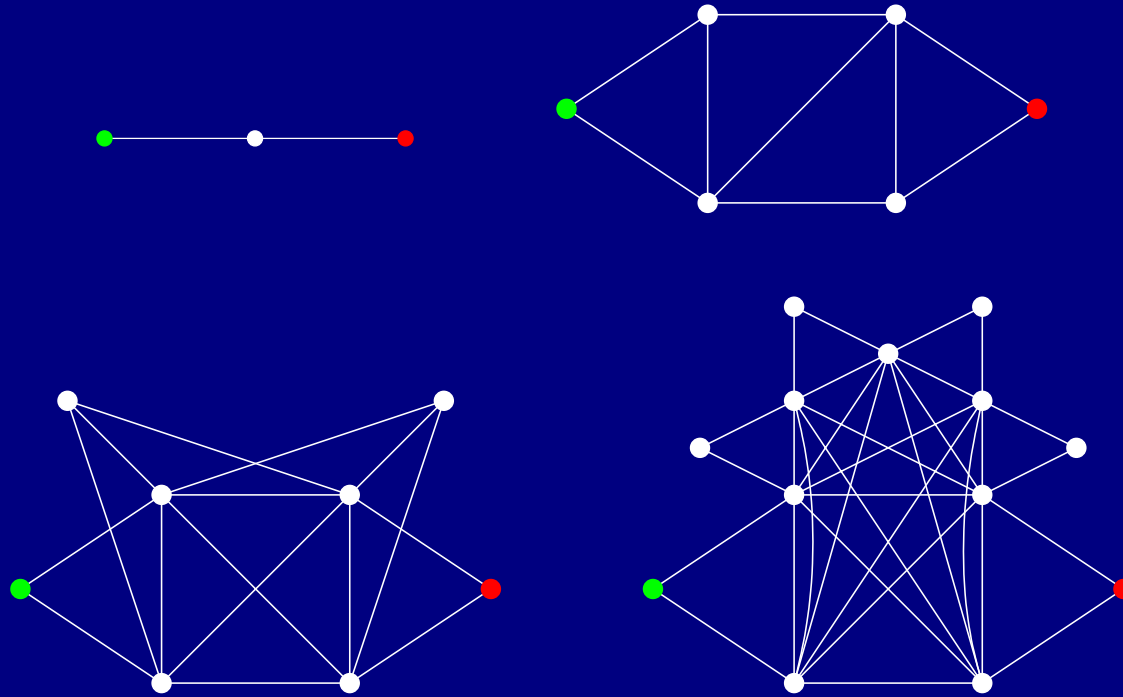

Property

In any directed path graph model the path between two vertices that are linked by a strong path is directed.

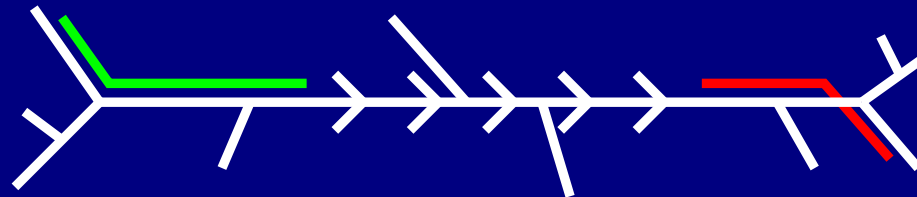

Strong asteroidal triple

Strong asteroidal triple

Definition

An asteroidal triple such that between any two of the vertices of the triple, there exists a strong path between them.

Strong asteroidal triple

Definition

An asteroidal triple such that between any two of the vertices of the triple, there exists a strong path between them.

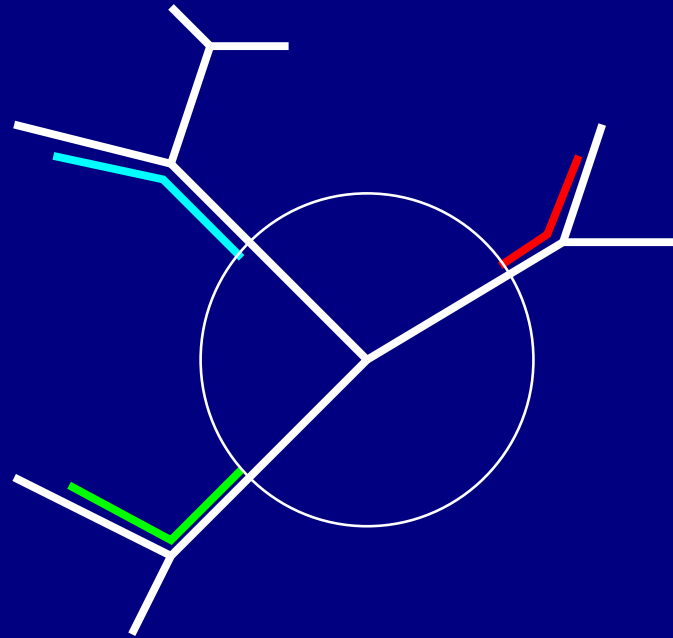

Strong asteroidal triple

Definition

An asteroidal triple such that between any two of the vertices of the triple, there exists a strong path between them.

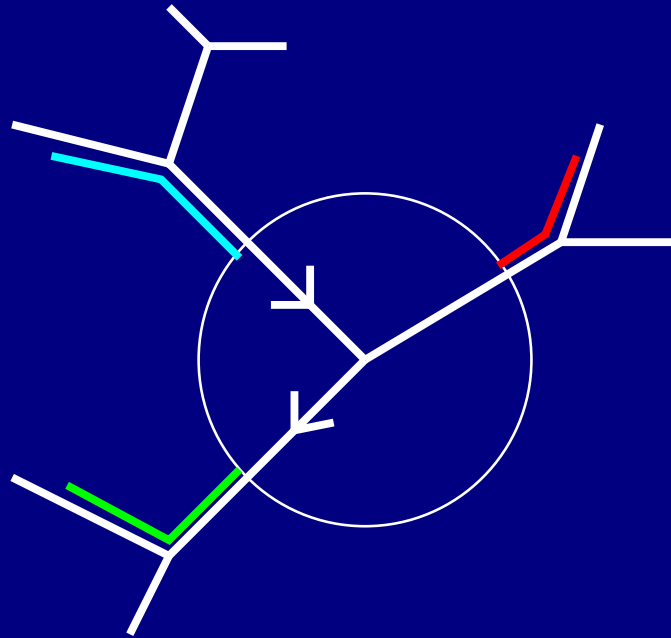

Strong asteroidal triple

Definition

An asteroidal triple such that between any two of the vertices of the triple, there exists a strong path between them.



Strong asteroidal triple

Definition

An asteroidal triple such that between any two of the vertices of the triple, there exists a strong path between them.

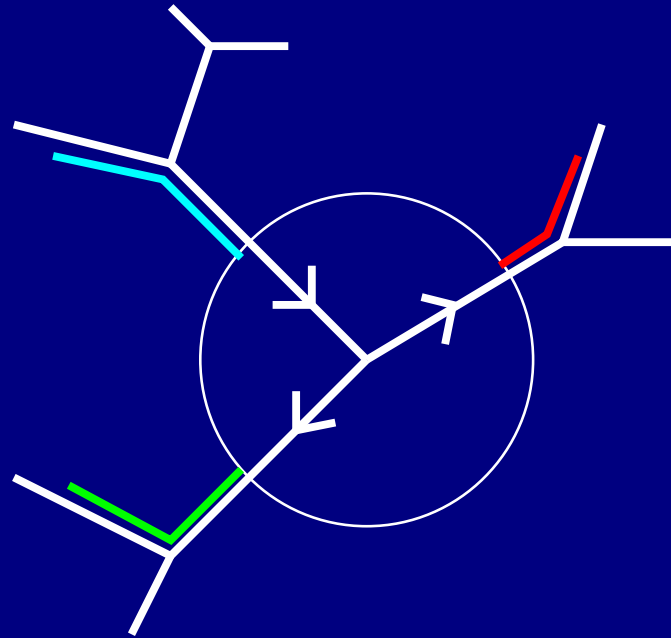

Theorem (Cameron, Hoàng, Lévêque - 2009)

Strong asteroidal triple

Definition

An asteroidal triple such that between any two of the vertices of the triple, there exists a strong path between them.

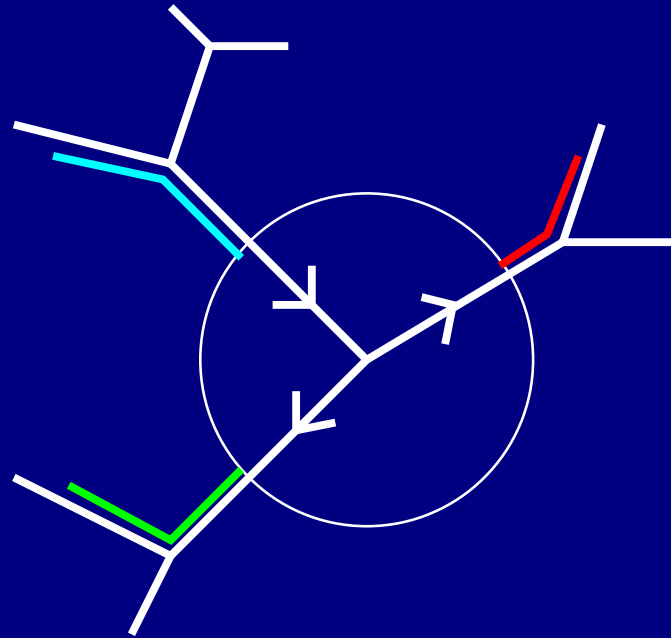

Theorem (Cameron, Hoàng, Lévêque - 2009)

Directed path graph \iff chordal + no strong asteroidal triple

Rooted path graphs

Definition

Intersection graph of a family of directed subpaths of a rooted tree

Rooted path graphs

Definition

Intersection graph of a family of directed subpaths of a rooted tree

Open problem

Forbidden induced subgraph characterization ?

Rooted path graphs

Definition

Intersection graph of a family of directed subpaths of a rooted tree

Open problem

Forbidden induced subgraph characterization ?

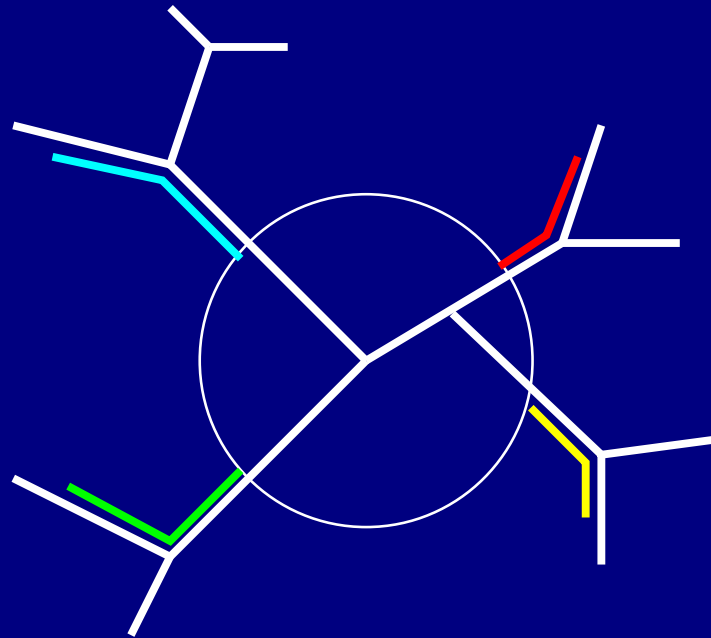

Rooted path graphs

Definition

Intersection graph of a family of directed subpaths of a rooted tree

Open problem

Forbidden induced subgraph characterization ?

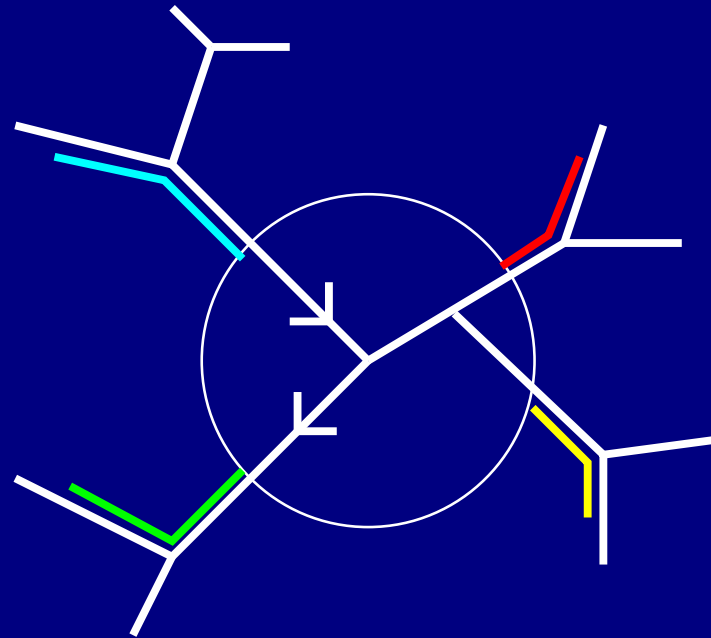

Rooted path graphs

Definition

Intersection graph of a family of directed subpaths of a rooted tree

Open problem

Forbidden induced subgraph characterization ?

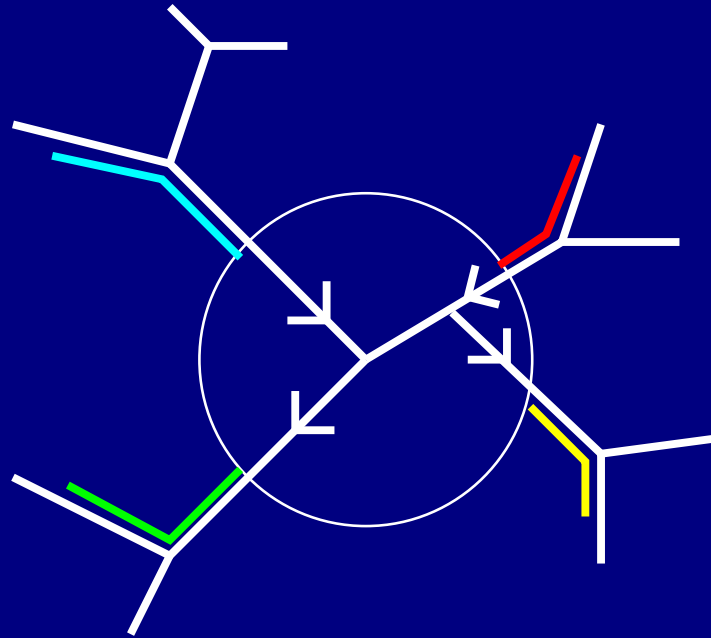

Rooted path graphs

Definition

Intersection graph of a family of directed subpaths of a rooted tree

Open problem

Forbidden induced subgraph characterization ?

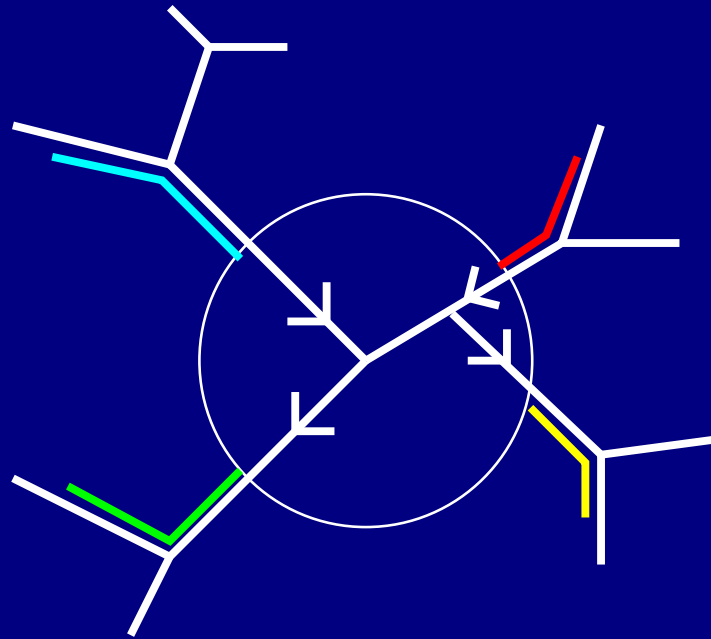

Conjecture

Rooted path graphs

Definition

Intersection graph of a family of directed subpaths of a rooted tree

Open problem

Forbidden induced subgraph characterization ?

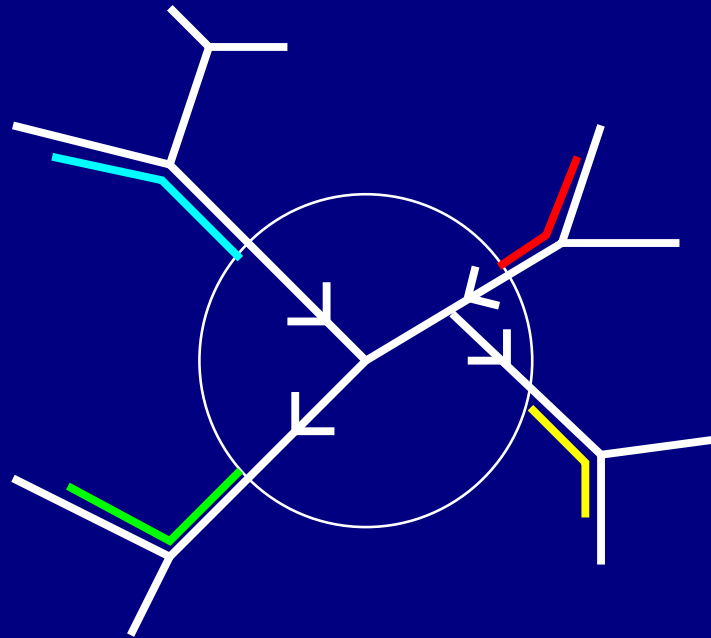

Conjecture

Rooted path graph \iff

chordal + no strong asteroidal triple + no weak asteroidal quadruple

Summary of results and open problems

	forbidden subgraphs	forbidden asteroids
path graphs	[LMP09]	?
directed path graphs	[Pan99]	[CHL09]
rooted path graphs	?	?
interval graphs	[LB62]	[LB62]

Recognition algorithms

Recognition algorithms

- Chordal graphs : $\mathcal{O}(n + m)$ (Rose, Tarjan, Lueker - 1976)

Recognition algorithms

- Chordal graphs : $\mathcal{O}(n + m)$ (Rose, Tarjan, Lueker - 1976)
- Interval graphs : $\mathcal{O}(n + m)$ (Booth, Lueker - 1976) ... and many others

Recognition algorithms

- Chordal graphs : $\mathcal{O}(n + m)$ (Rose, Tarjan, Lueker - 1976)
- Interval graphs : $\mathcal{O}(n + m)$ (Booth, Lueker - 1976) ... and many others
- Path graphs :

Recognition algorithms

- Chordal graphs : $\mathcal{O}(n + m)$ (Rose, Tarjan, Lueker - 1976)
- Interval graphs : $\mathcal{O}(n + m)$ (Booth, Lueker - 1976) ... and many others
- Path graphs : $\mathcal{O}(n^4)$ (Gavril - 1978)

Recognition algorithms

- Chordal graphs : $\mathcal{O}(n + m)$ (Rose, Tarjan, Lueker - 1976)
- Interval graphs : $\mathcal{O}(n + m)$ (Booth, Lueker - 1976) ... and many others
- Path graphs : $\mathcal{O}(n^4)$ (Gavril - 1978)

$\mathcal{O}(nm)$ (Schäffer - 1993)

Recognition algorithms

- Chordal graphs : $\mathcal{O}(n + m)$ (Rose, Tarjan, Lueker - 1976)
- Interval graphs : $\mathcal{O}(n + m)$ (Booth, Lueker - 1976) ... and many others
- Path graphs : $\mathcal{O}(n^4)$ (Gavril - 1978)

$\mathcal{O}(nm)$ (Schäffer - 1993)

$\mathcal{O}(nm)$ (Chaplick - 2008)

Recognition algorithms

- Chordal graphs : $\mathcal{O}(n + m)$ (Rose, Tarjan, Lueker - 1976)
- Interval graphs : $\mathcal{O}(n + m)$ (Booth, Lueker - 1976) ... and many others
- Path graphs : $\mathcal{O}(n^4)$ (Gavril - 1978)

$\mathcal{O}(nm)$ (Schäffer - 1993)

$\mathcal{O}(nm)$ (Chaplick - 2008)

$\mathcal{O}(n + m)$ (Dalhaus, Bailey - 1996) ??? conference paper

Recognition algorithms

- Chordal graphs : $\mathcal{O}(n + m)$ (Rose, Tarjan, Lueker - 1976)
- Interval graphs : $\mathcal{O}(n + m)$ (Booth, Lueker - 1976) ... and many others
- Path graphs : $\mathcal{O}(n^4)$ (Gavril - 1978)
 - $\mathcal{O}(nm)$ (Schäffer - 1993)
 - $\mathcal{O}(nm)$ (Chaplick - 2008)
 - $\mathcal{O}(n + m)$ (Dalhaus, Bailey - 1996) ??? conference paper
- Directed path graphs :

Recognition algorithms

- Chordal graphs : $\mathcal{O}(n + m)$ (Rose, Tarjan, Lueker - 1976)
- Interval graphs : $\mathcal{O}(n + m)$ (Booth, Lueker - 1976) ... and many others
- Path graphs : $\mathcal{O}(n^4)$ (Gavril - 1978)

$\mathcal{O}(nm)$ (Schäffer - 1993)

$\mathcal{O}(nm)$ (Chaplick - 2008)

$\mathcal{O}(n + m)$ (Dalhaus, Bailey - 1996) ??? conference paper

- Directed path graphs \iff Path graph with no odd suns

Recognition algorithms

- Chordal graphs : $\mathcal{O}(n + m)$ (Rose, Tarjan, Lueker - 1976)
- Interval graphs : $\mathcal{O}(n + m)$ (Booth, Lueker - 1976) ... and many others
- Path graphs : $\mathcal{O}(n^4)$ (Gavril - 1978)

$\mathcal{O}(nm)$ (Schäffer - 1993)

$\mathcal{O}(nm)$ (Chaplick - 2008)

$\mathcal{O}(n + m)$ (Dalhaus, Bailey - 1996) ??? conference paper

- Directed path graphs \iff Path graph with no odd suns

Corollary As fast as path graph !

Recognition algorithms

- Chordal graphs : $\mathcal{O}(n + m)$ (Rose, Tarjan, Lueker - 1976)
- Interval graphs : $\mathcal{O}(n + m)$ (Booth, Lueker - 1976) ... and many others
- Path graphs : $\mathcal{O}(n^4)$ (Gavril - 1978)

$\mathcal{O}(nm)$ (Schäffer - 1993)

$\mathcal{O}(nm)$ (Chaplick - 2008)

$\mathcal{O}(n + m)$ (Dalhaus, Bailey - 1996) ??? conference paper

- Directed path graphs \iff Path graph with no odd suns

Corollary As fast as path graph !

- Rooted path graphs : $\mathcal{O}(n + m)$ (Dietz - 1984) ??? thesis